



# Fv. 5161 Åsen–Helleskaret

Bjørnafjorden kommune

## TEKNISKE DATA

Fra – til profil:	0 – 1350
Dimensjoneringsklasse:	HØ2
Fartsgrense (ÅDT):	60 km/t
Trafikkgrunnlag:	3500(2021)



# TEIKNINGSLISTE

PROSJEKTNAMN

A002

DATO

Teikn. nr.	Arkiv nummer	Teikningstittel	Teikningsdato.	Revisjon		Merknadar
				Nr	Dato	
A001		Framsida	20.05.2021			
A002		Teikningsliste	20.05.2021			
<b>B-teikningar</b>						
B001		Oversiktsteikning	20.05.2021			
<b>C-teikningar</b>						
C001		Plan og profilteikning hovedveg	20.05.2021			
C002		Plan og profilteikning hovedveg	20.05.2021			
<b>D-teikningar</b>						
D001		Plan og profilteikning sidevegar, Søvikvegen og Ole Bulls veg	20.05.2021			
D002		Plan og profilteikning sidevegar, tilkomstveg Revsåsen og Åsen	20.05.2021			
<b>F-teikningar</b>						
F001		Normalprofil, Hovedveg	18.05.2020			
F001		Normalprofil, Sidevegar	18.05.2020			
<b>U-teikningar</b>						
U001		Tverrprofilar	19.05.2021			
U002		Tverrprofilar	19.05.2021			
U003		Tverrprofilar	19.05.2021			
U004		Tverrprofilar	19.05.2021			
U005		Tverrprofilar	19.05.2021			
U006		Tverrprofilar	19.05.2021			
U007		Tverrprofilar	19.05.2021			
U008		Tverrprofilar	19.05.2021			
U009		Tverrprofilar	19.05.2021			
U010		Tverrprofilar	19.05.2021			
U011		Tverrprofilar	19.05.2021			
U012		Tverrprofilar	19.05.2021			
U013		Tverrprofilar	19.05.2021			
U014		Tverrprofilar	19.05.2021			
U015		Tverrprofilar	19.05.2021			
U016		Tverrprofilar	19.05.2021			
U017		Tverrprofilar	19.05.2021			
U101		Tverrprofilar	19.05.2021			
U102		Tverrprofilar	19.05.2021			
U103		Tverrprofilar	19.05.2021			
U201		Tverrprofilar	19.05.2021			
U202		Tverrprofilar	19.05.2021			
U203		Tverrprofilar	19.05.2021			
U204		Tverrprofilar	19.05.2021			
U205		Tverrprofilar	19.05.2021			

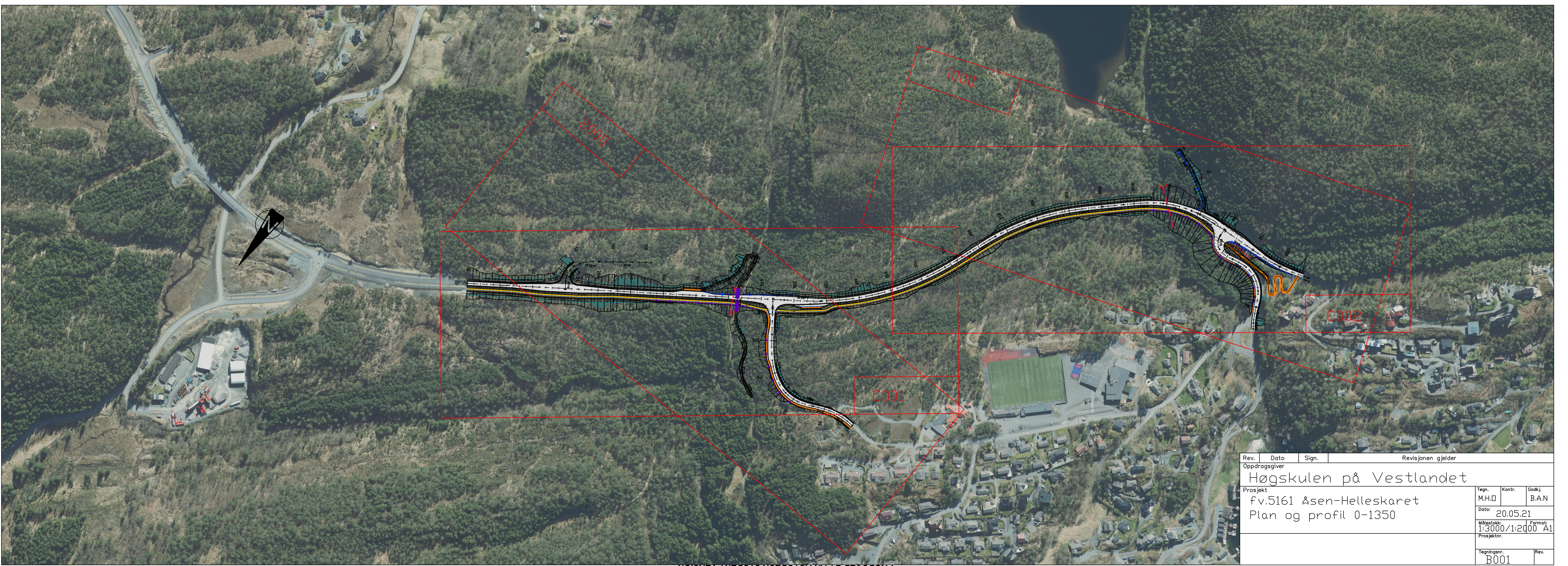
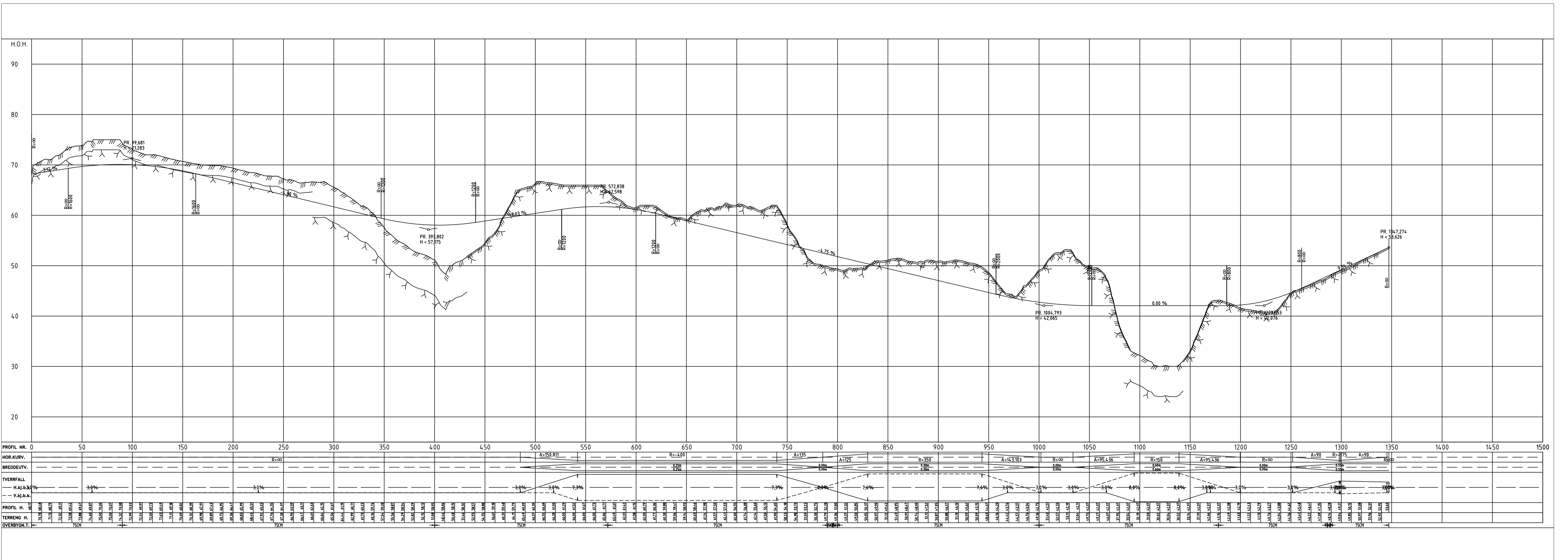

Rev.	Dato	Sign.	Revisjonen gjelder		
			Oppdragsgiver		
			Høgskulen på Vestlandet		
			Prosjekt		
			fv.5161 Åsen-Helleskaret		
			Plan og profil 0-1350		
Tegn.	Kontr.	Godkj.			
M.H.D	B.A.N				
Dato:	20.05.21				
Måstokk:	1:3000/1:2000 A1				
Prosjektør:					
Tegningen:	B001				
Rev.					

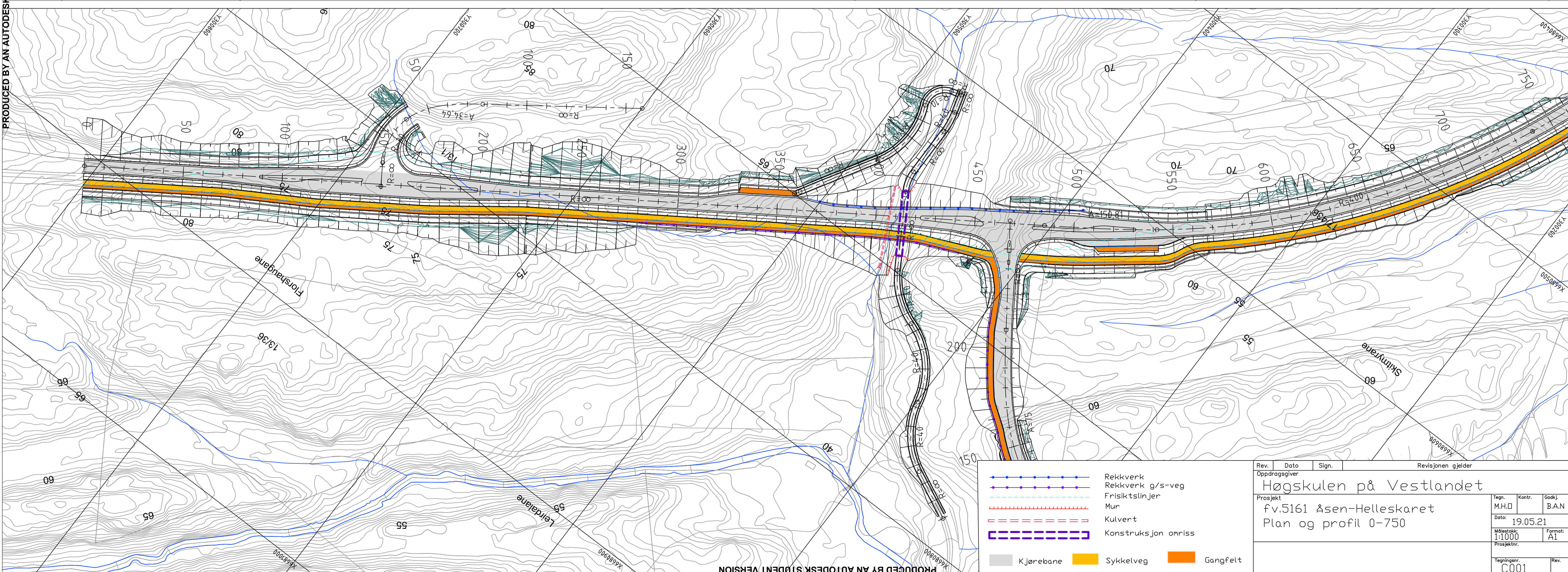
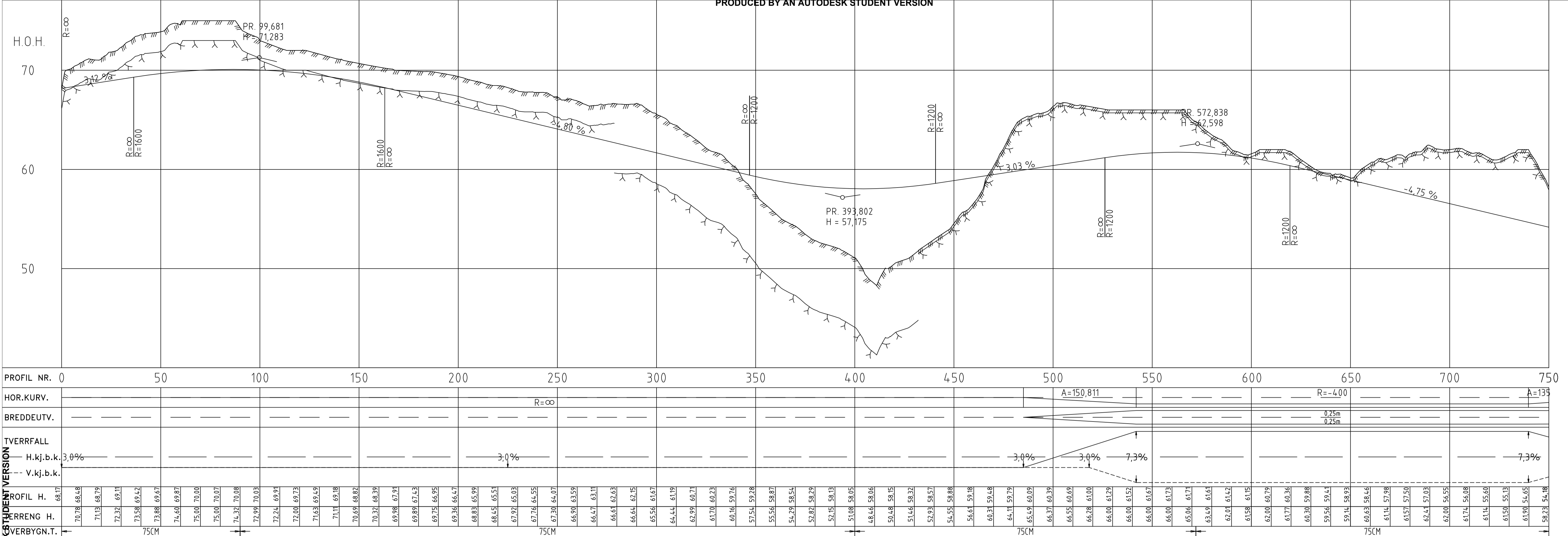

PRODUCED BY AN AUTODESK STUDENT VERSION

PRODUCED BY AN AUTODESK STUDENT VERSION

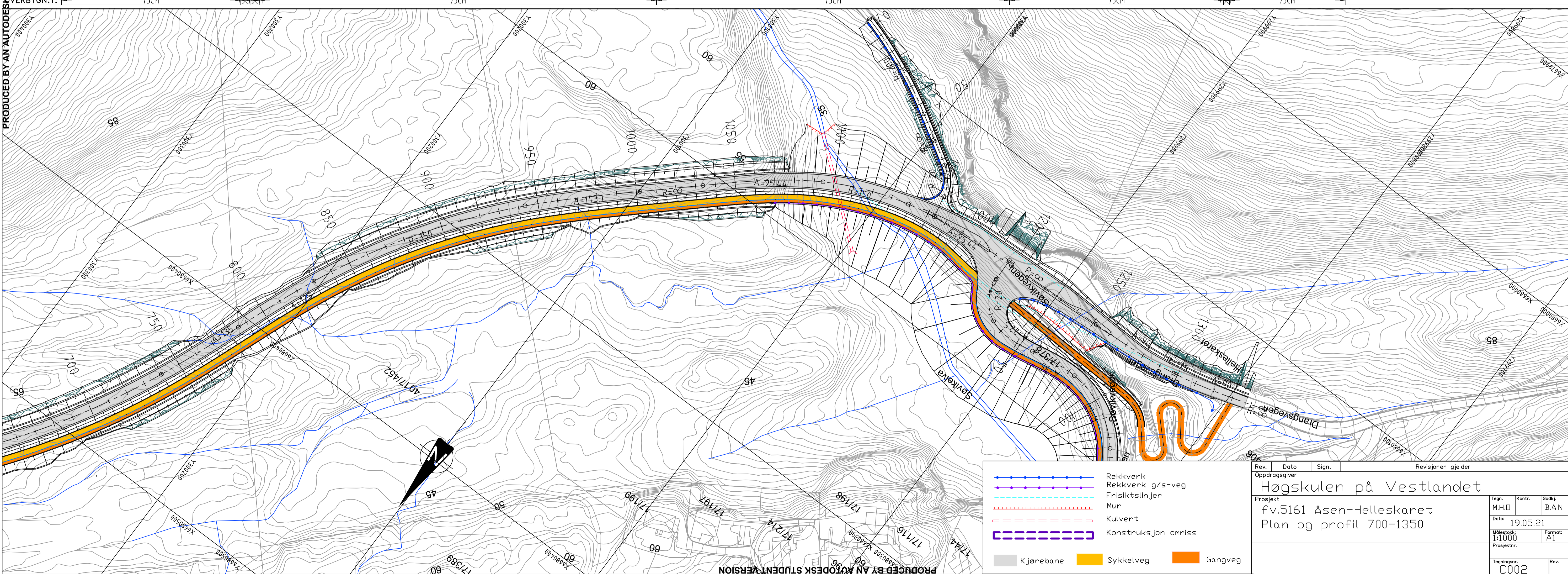
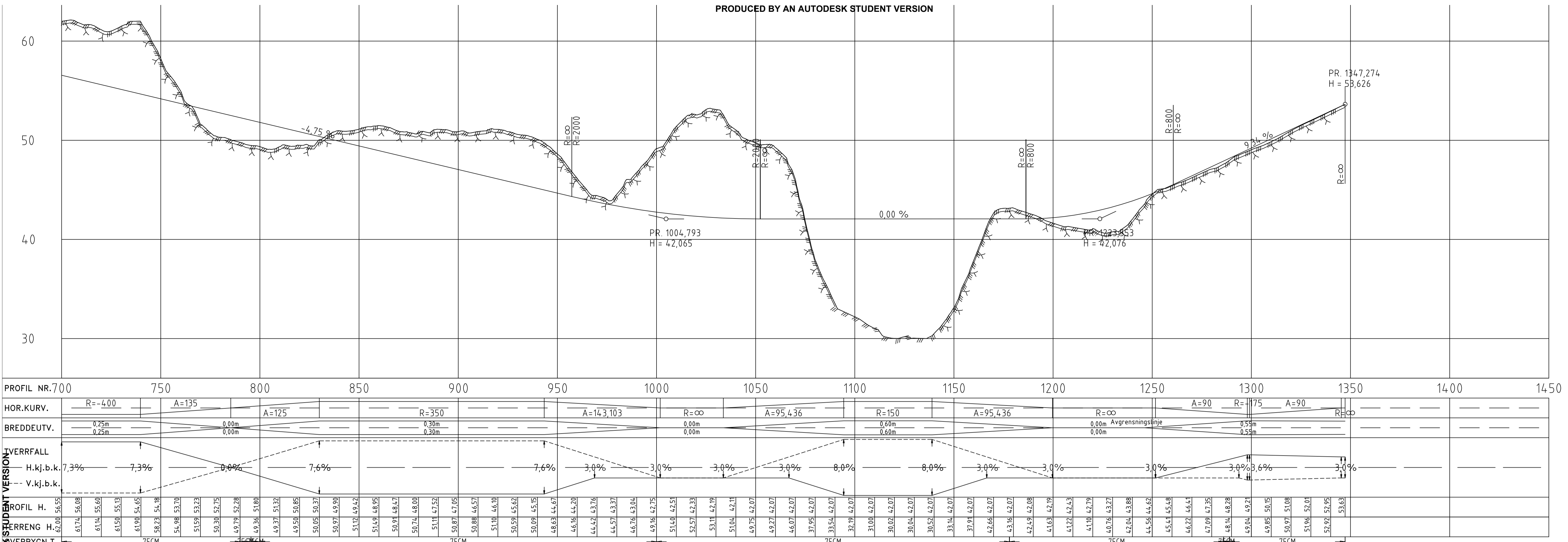

PRODUCED BY AN AUTODESK STUDENT VERSION

PRODUCED BY AN AUTODESK STUDENT VERSION

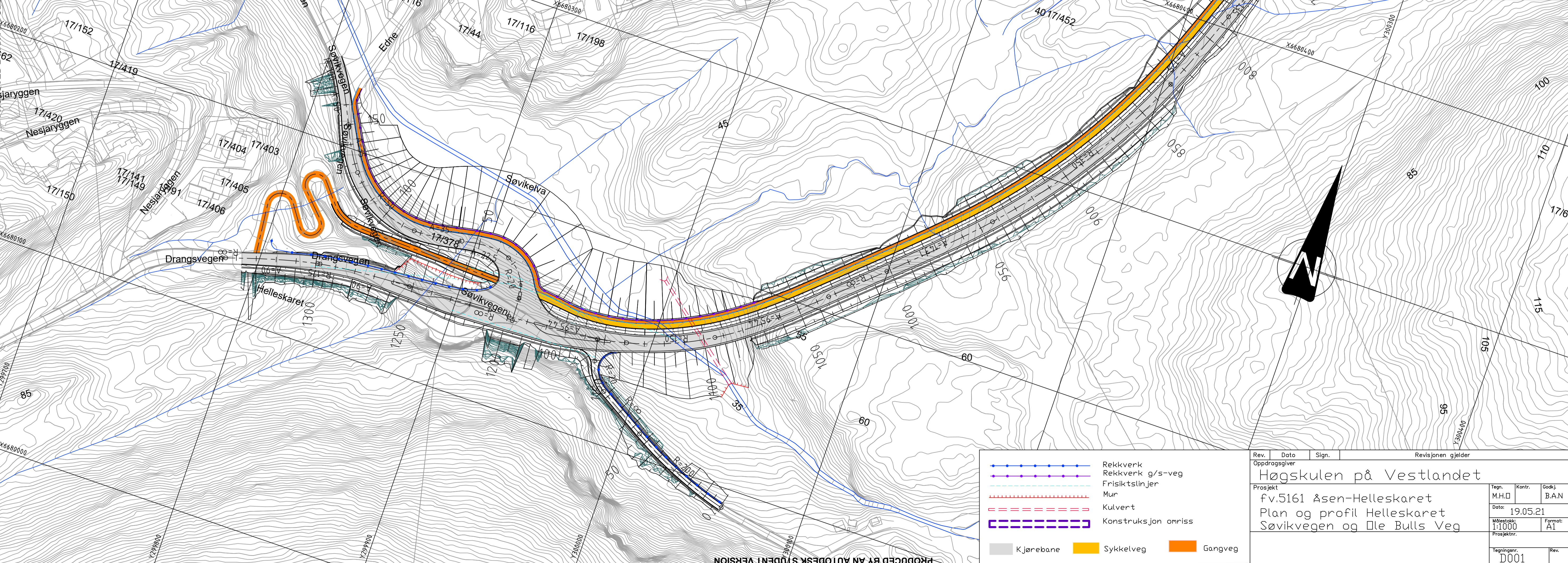
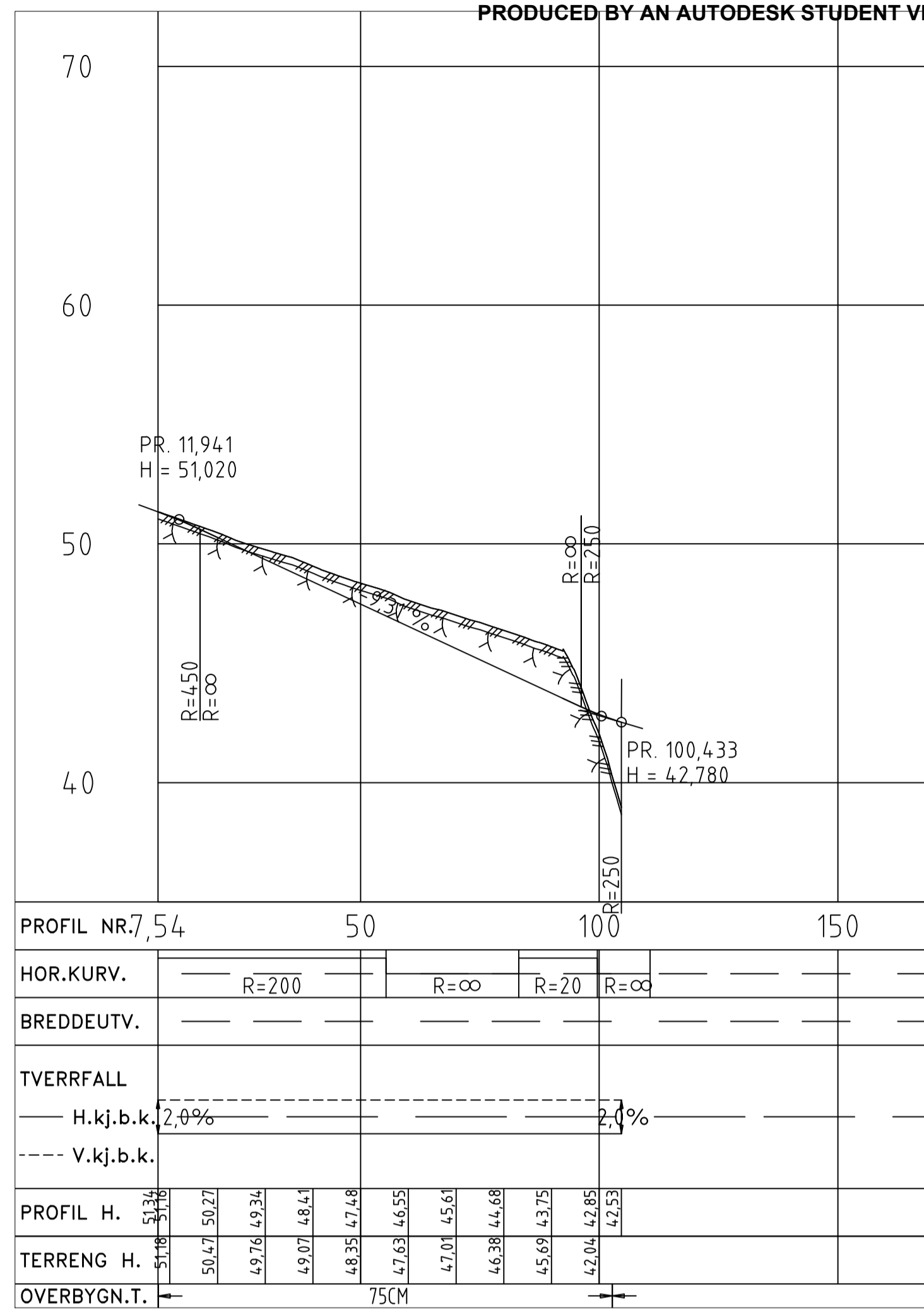
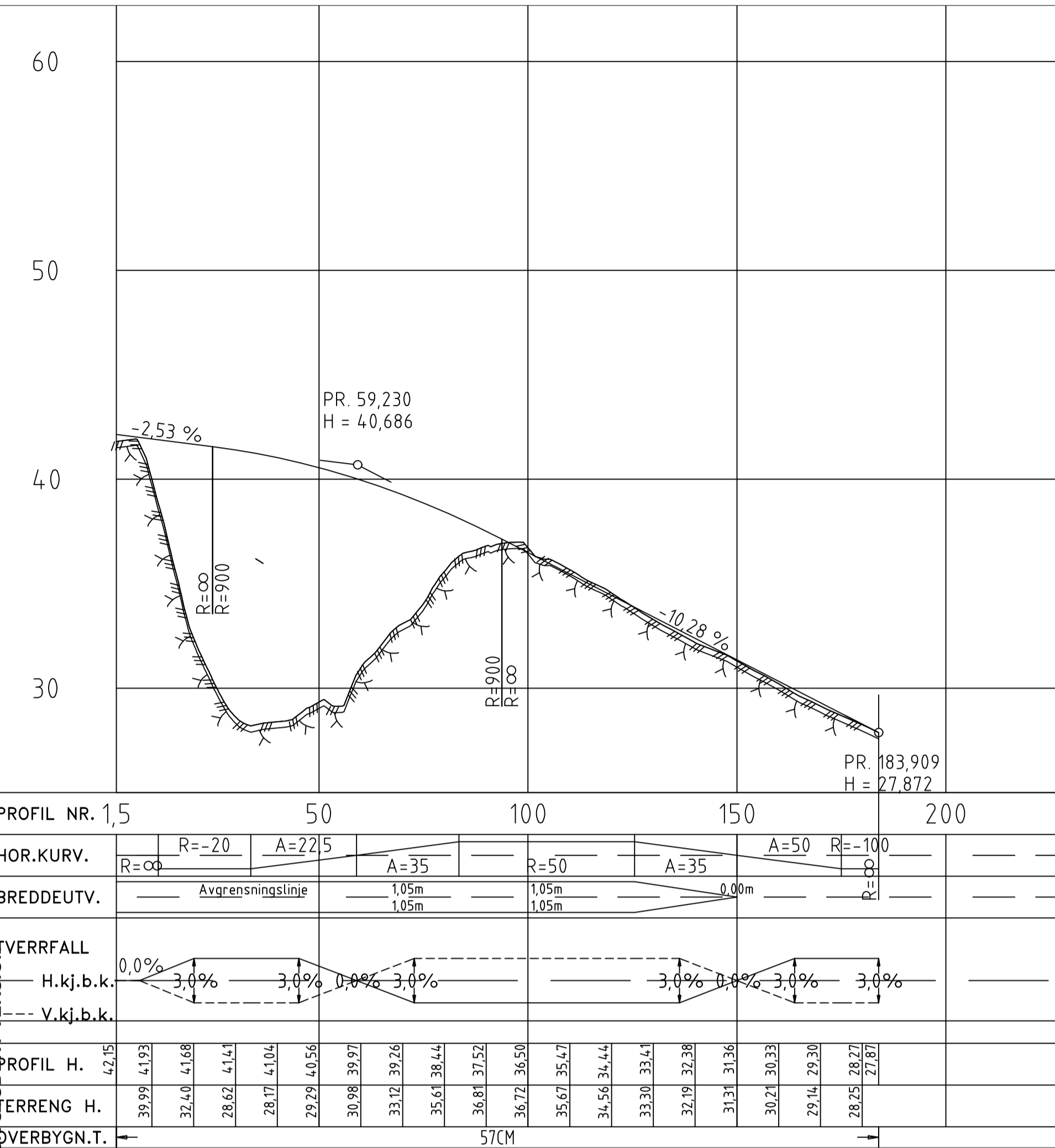

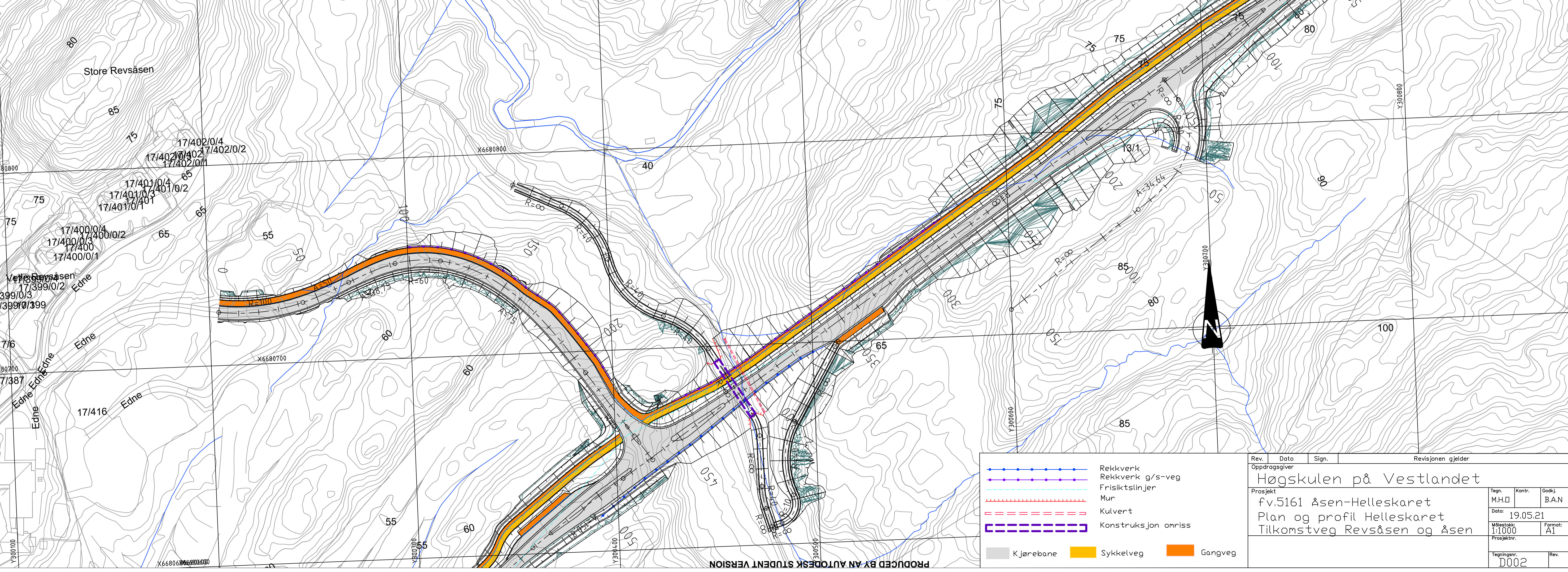
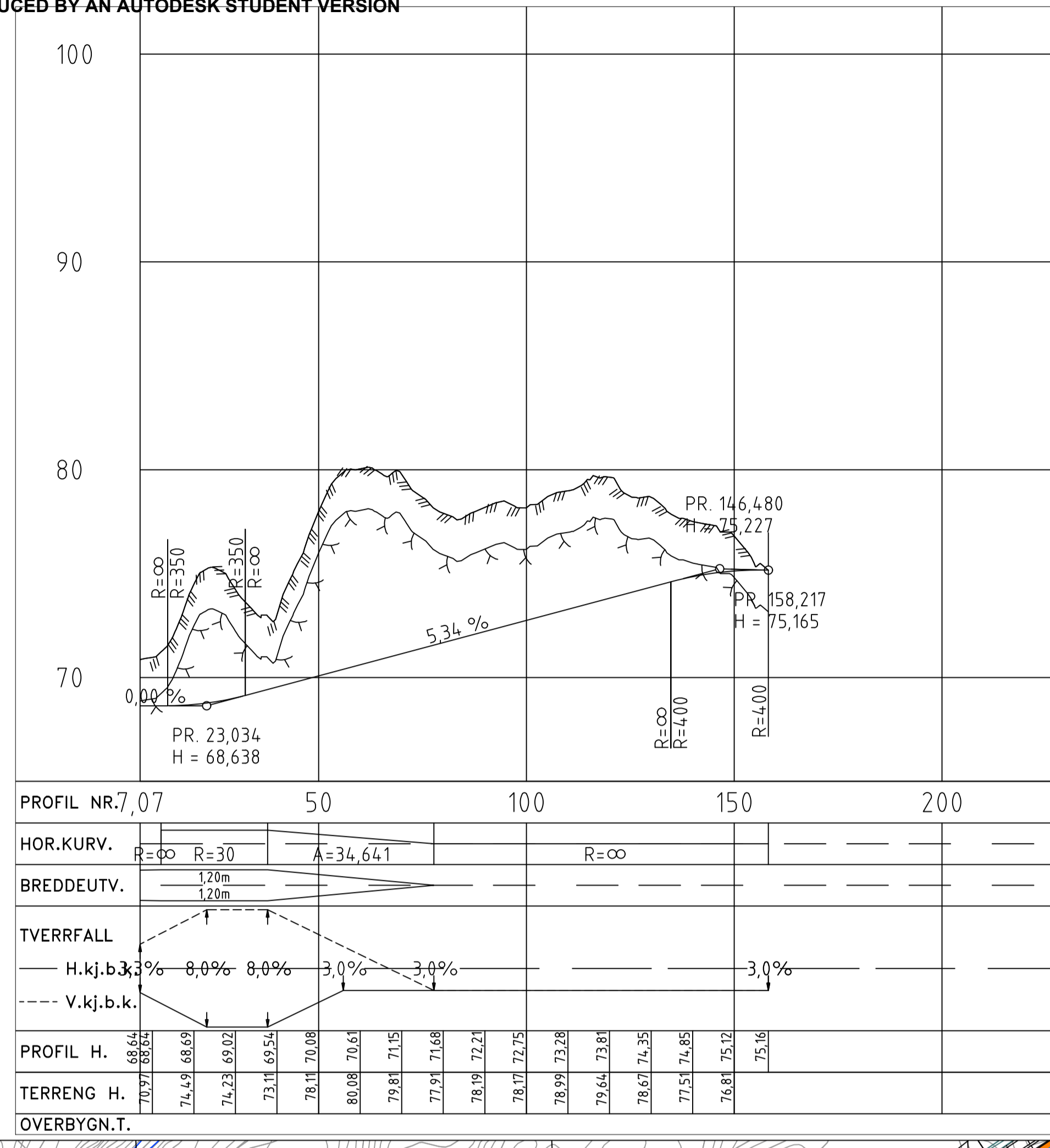
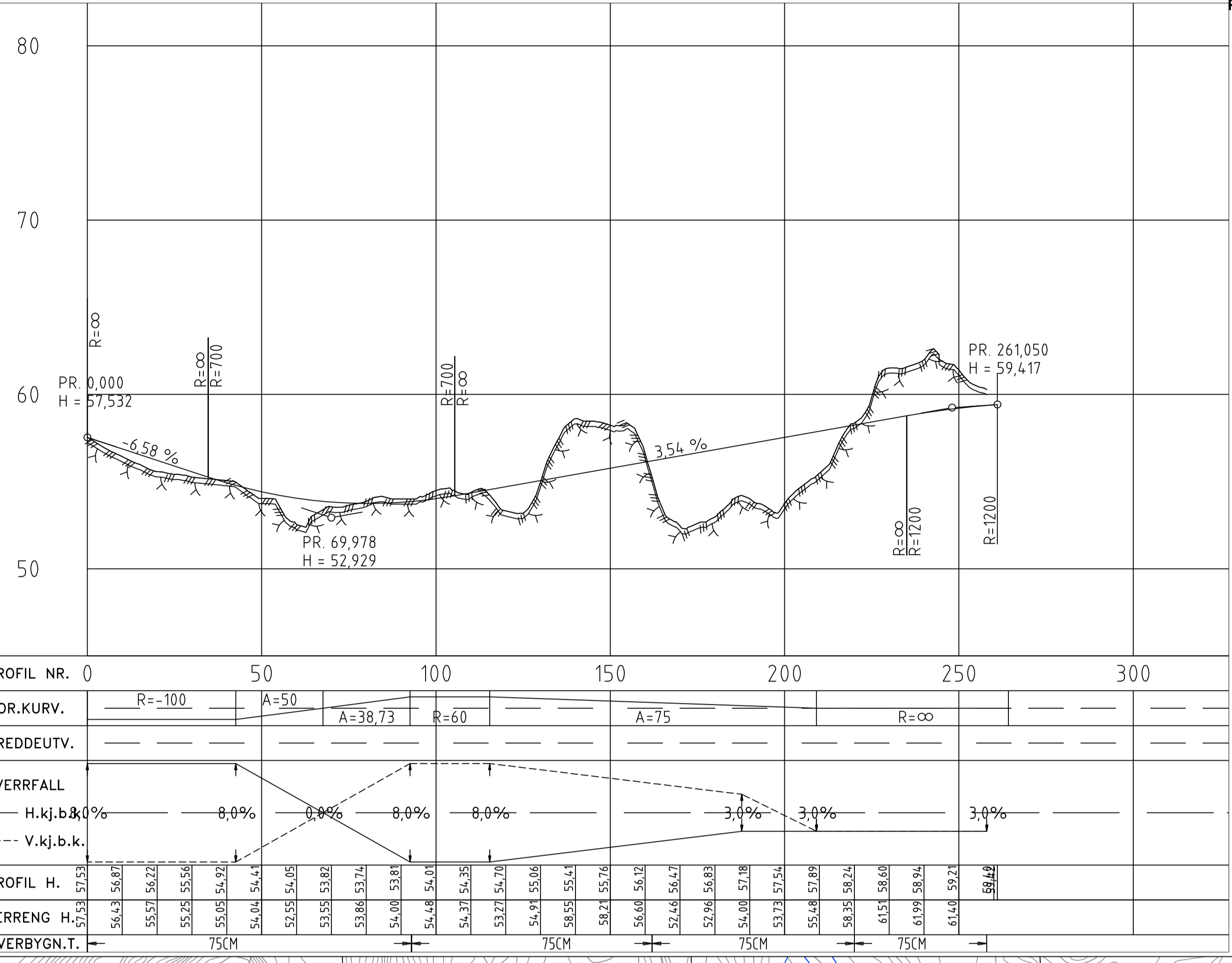

Normalprofil  
Åsen-Helleskaret  
Skjæringsprofil

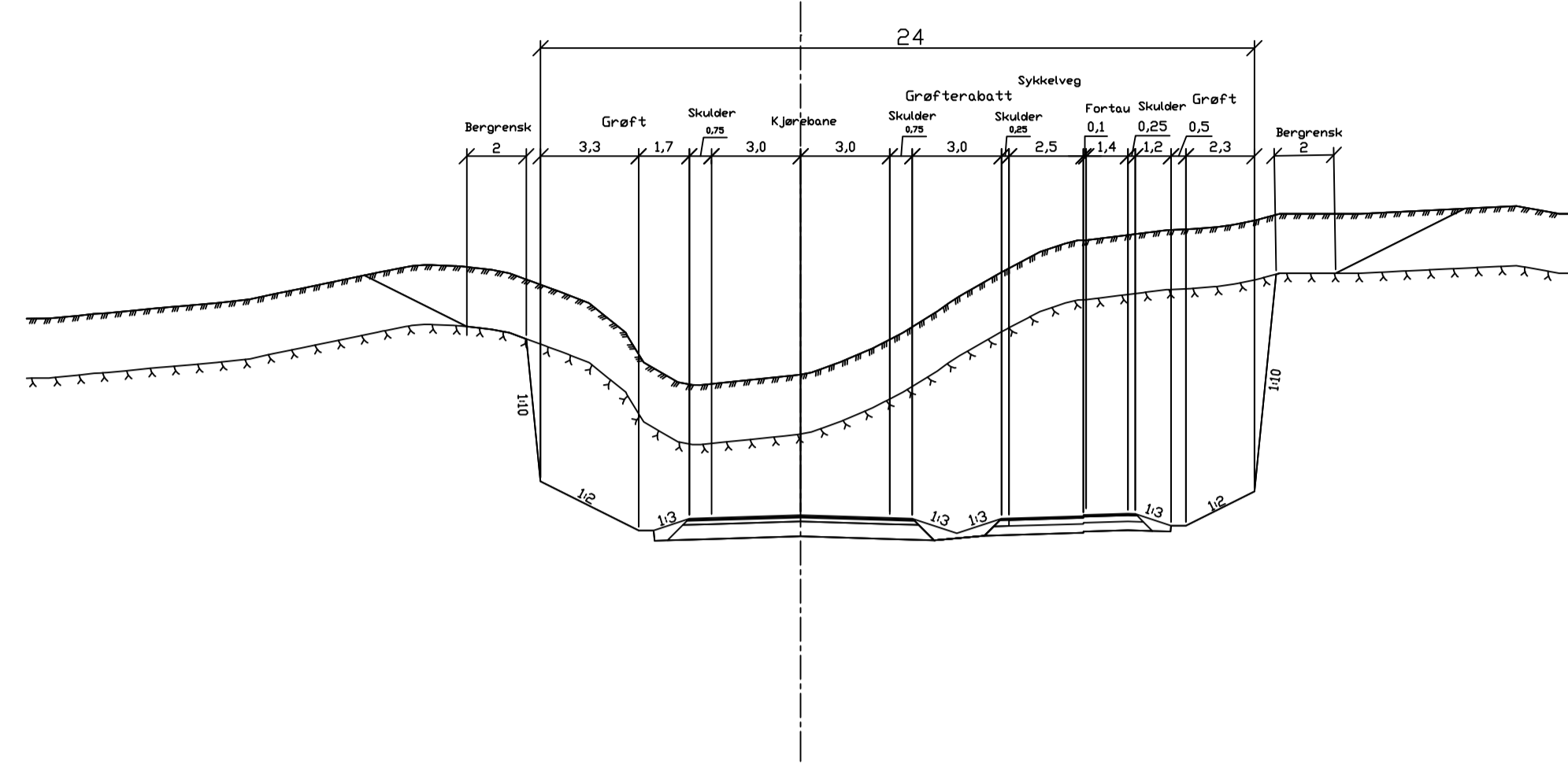

Normalprofil  
Åsen-Helleskaret  
Skjæring/fyllingsprofil

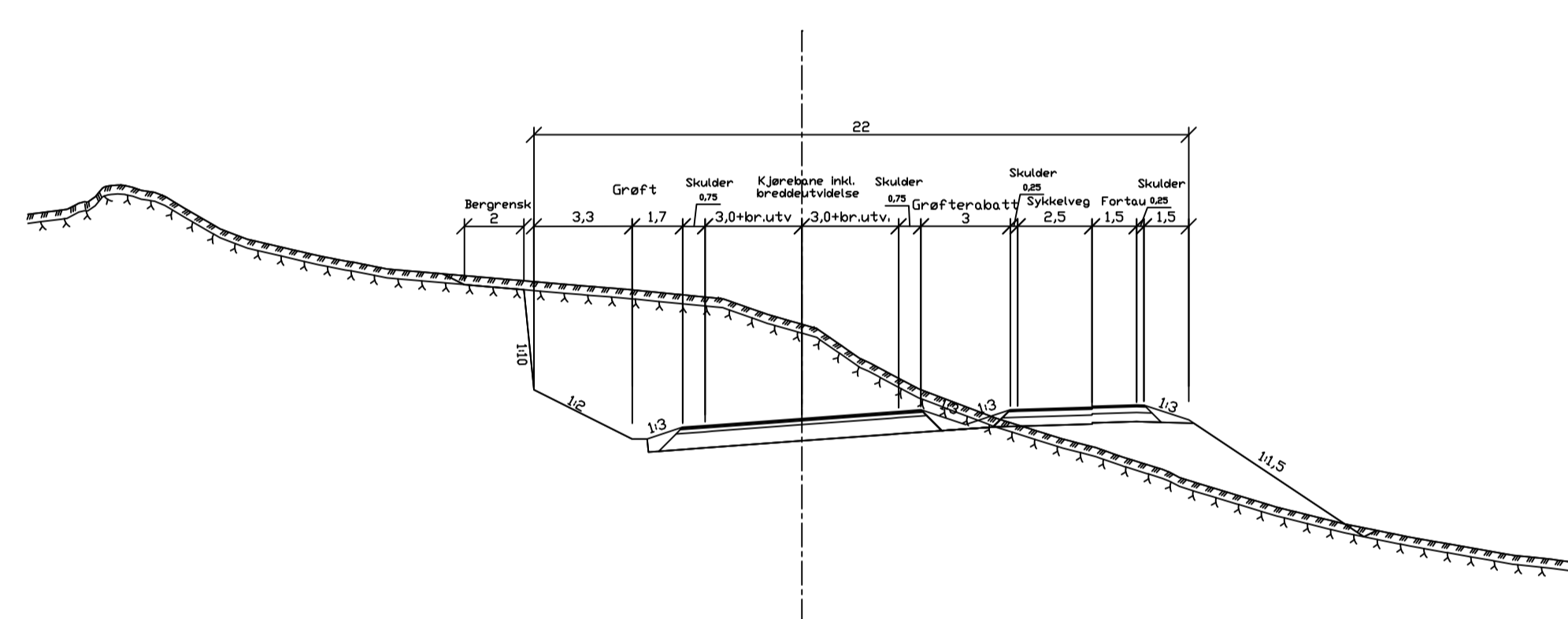

Normalprofil  
Åsen-Helleskaret  
Fyllingsprofil m/bakkeplanering

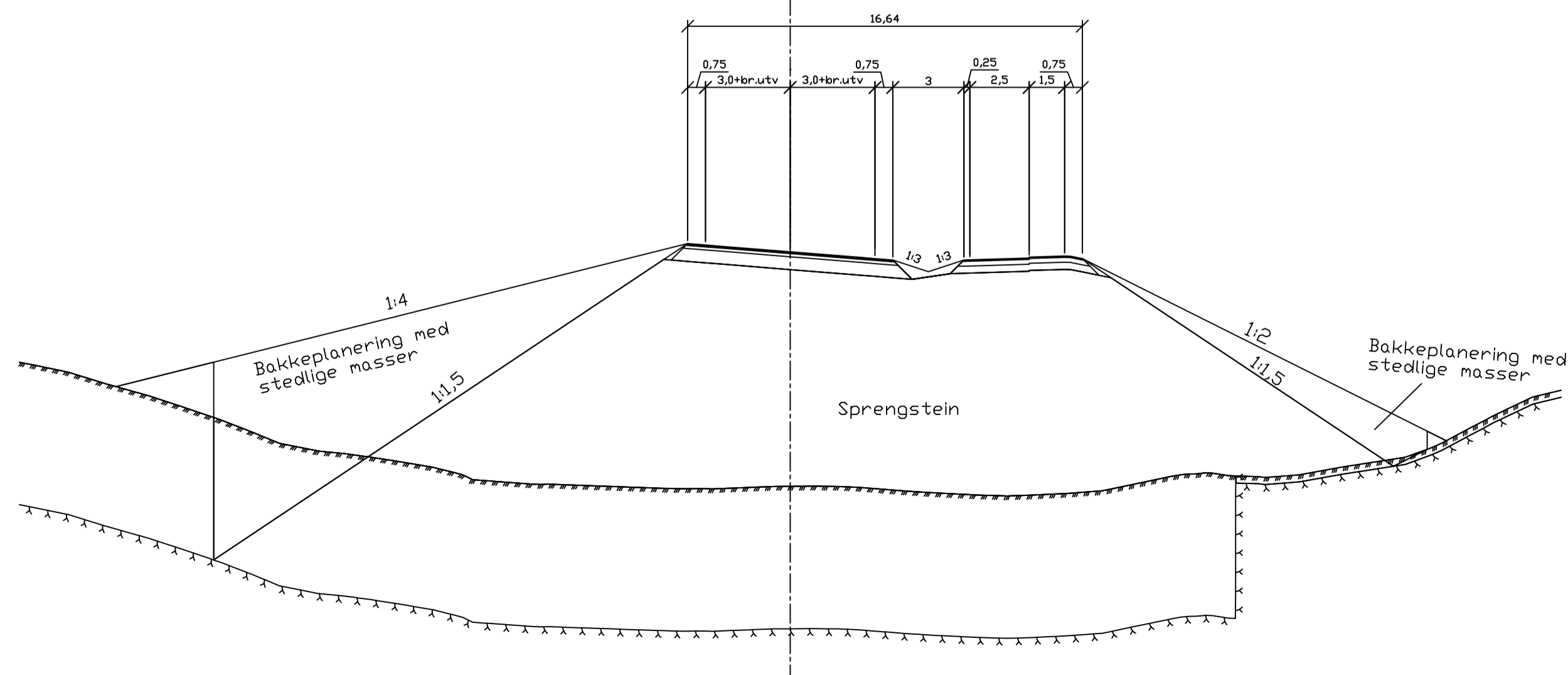

Overbygning  
Åsen-Helleskaret

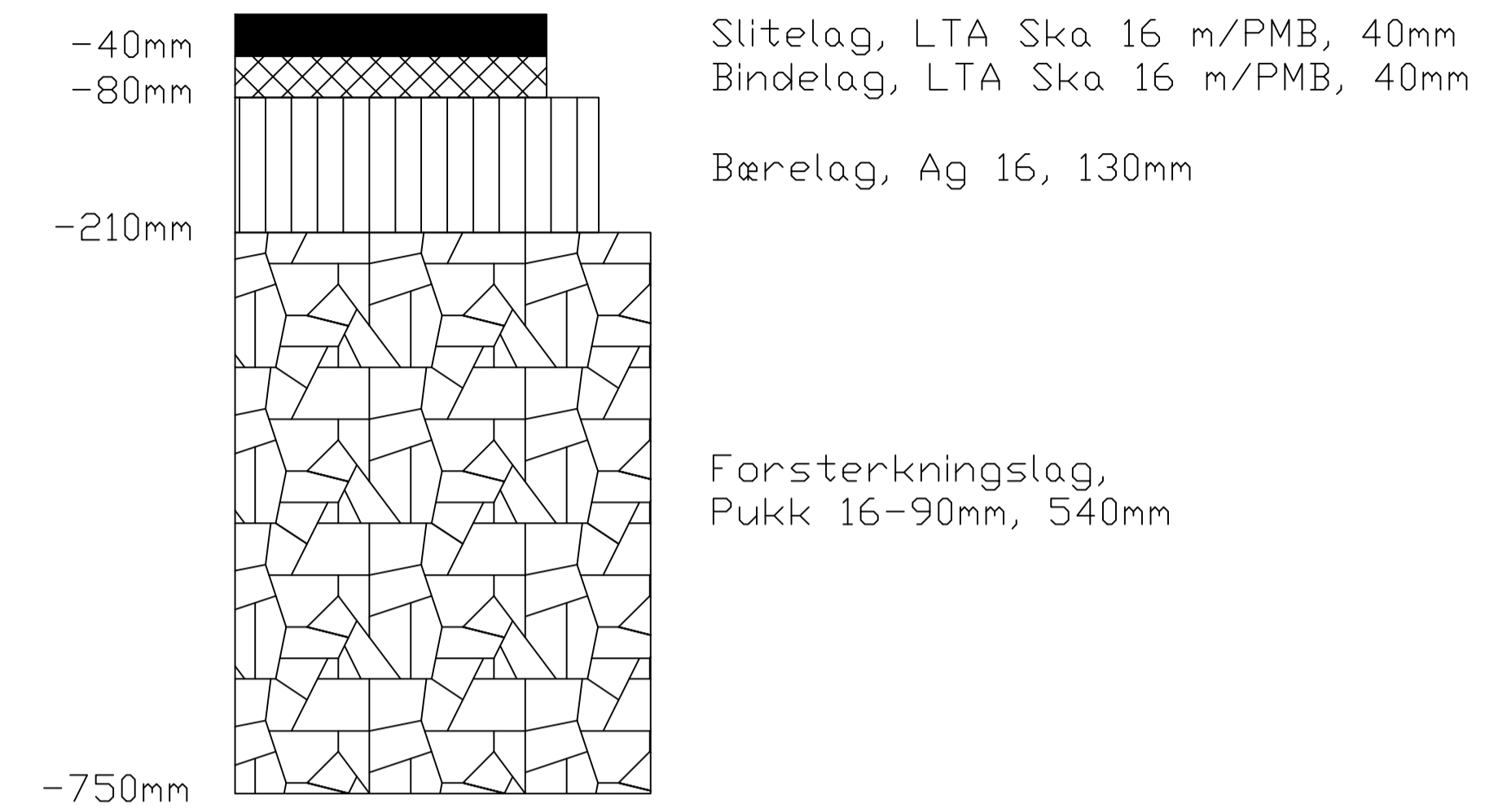

Rev.	Data	Sign.	Revisjonen gjelder		
Oppdragsgiver			Høgskulen på Vestlandet		
Prosjekt			Tegn.	Kontr.	Godkj.
fv.5161 Åsen-Helleskaret			M.H.Ø		B.A.N
Normalprofil og Overbygning			Date:	18.05.21	
			Målestokk:	1:200	
			Prosjektør:	A1	
			Tegningsnr.	F 001	
			Rev.		



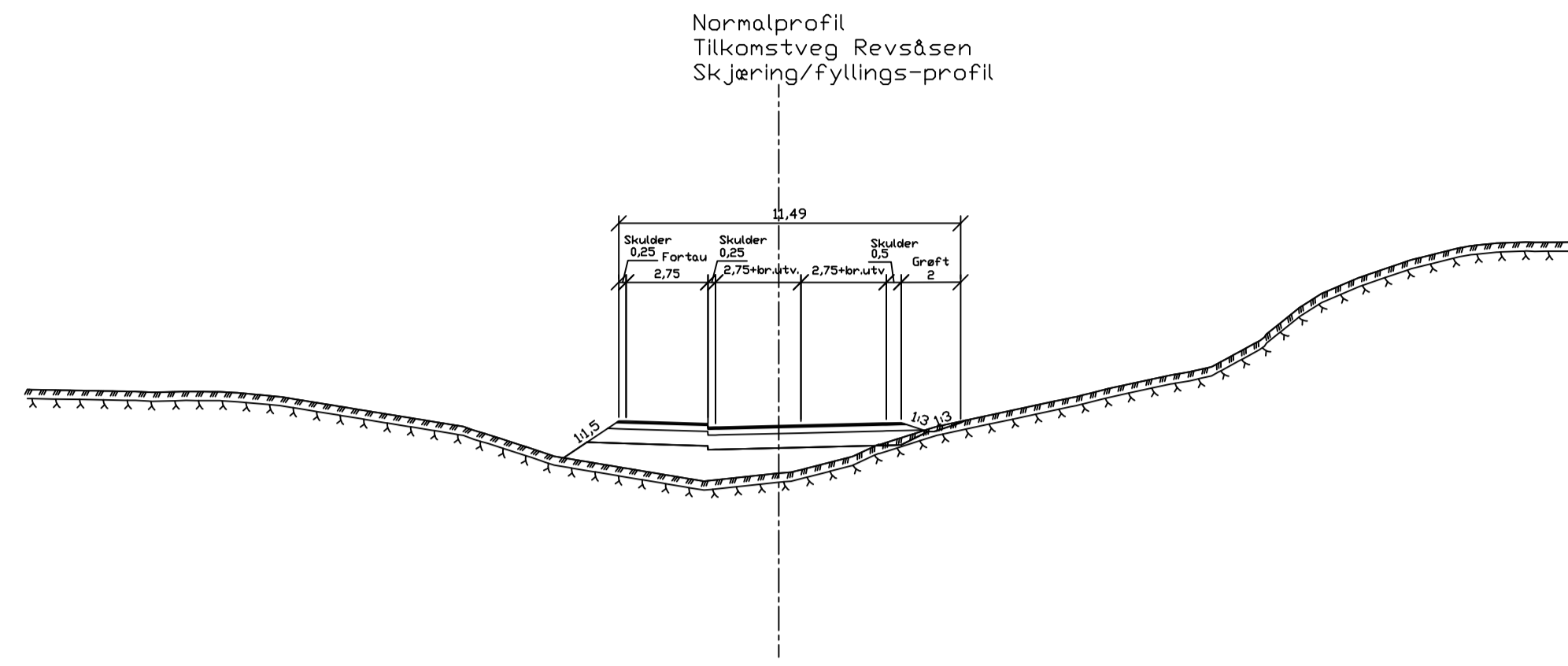

Overbygning  
Tilkomstvegen Revs&sen

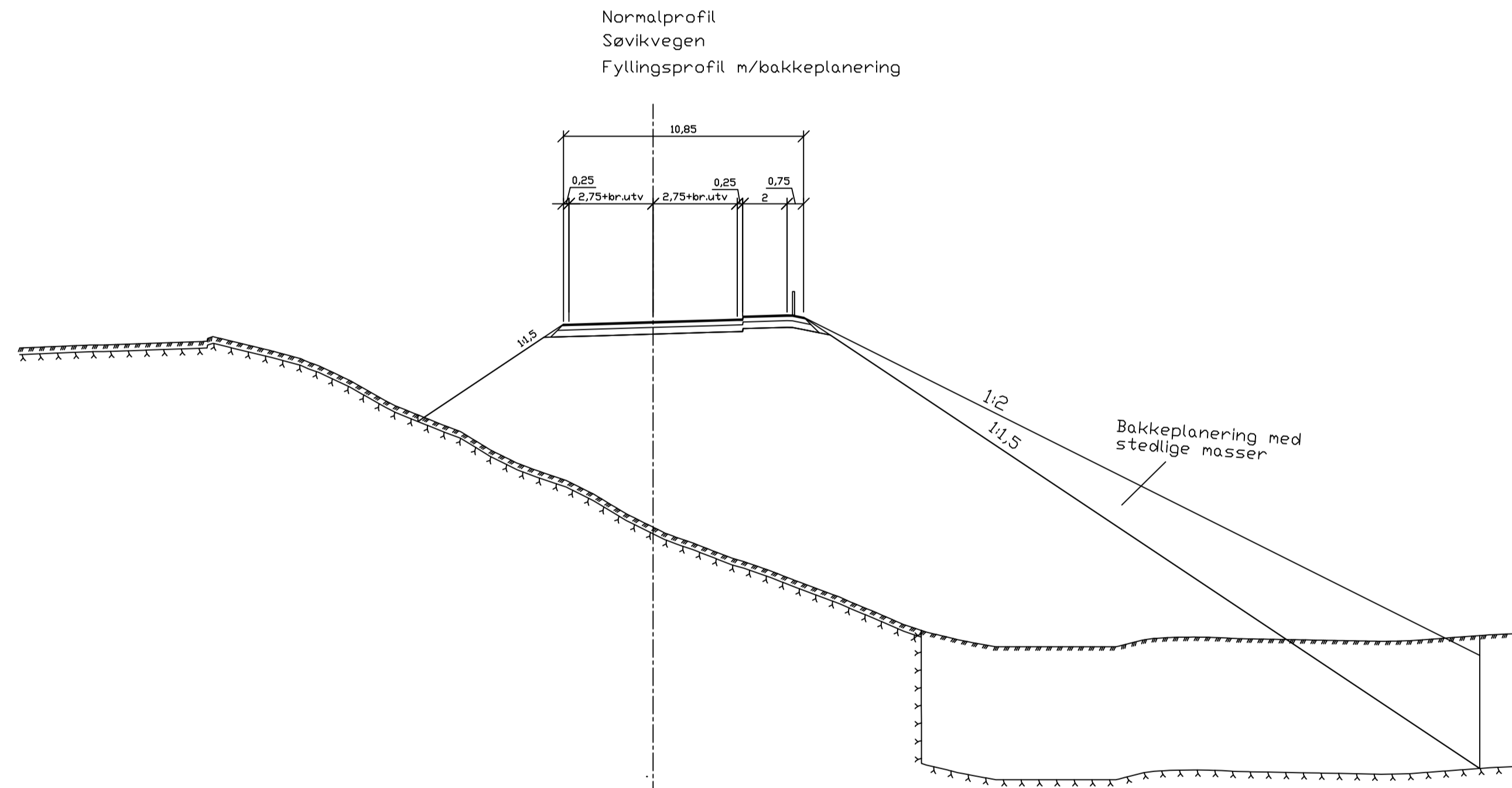
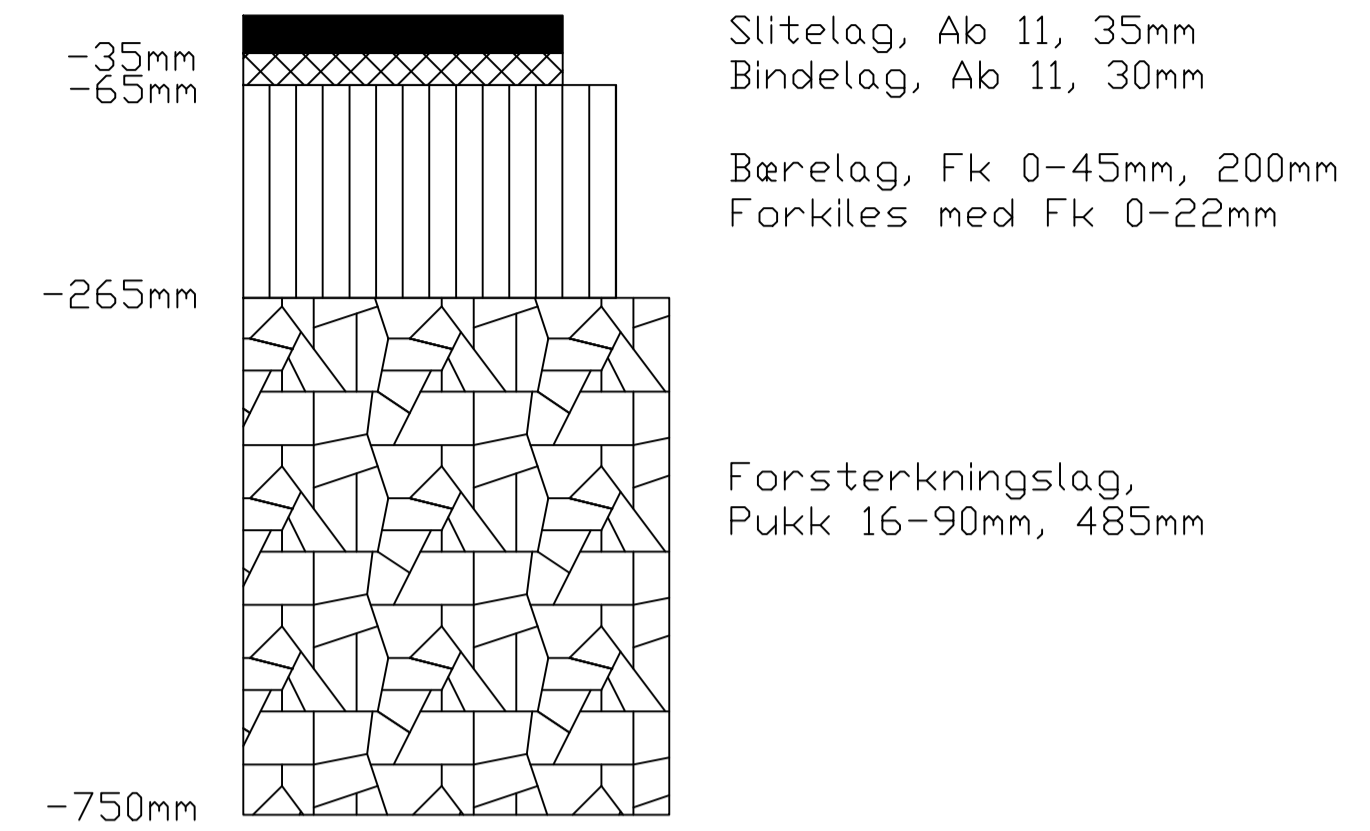

Overbygning  
Søvikvegen

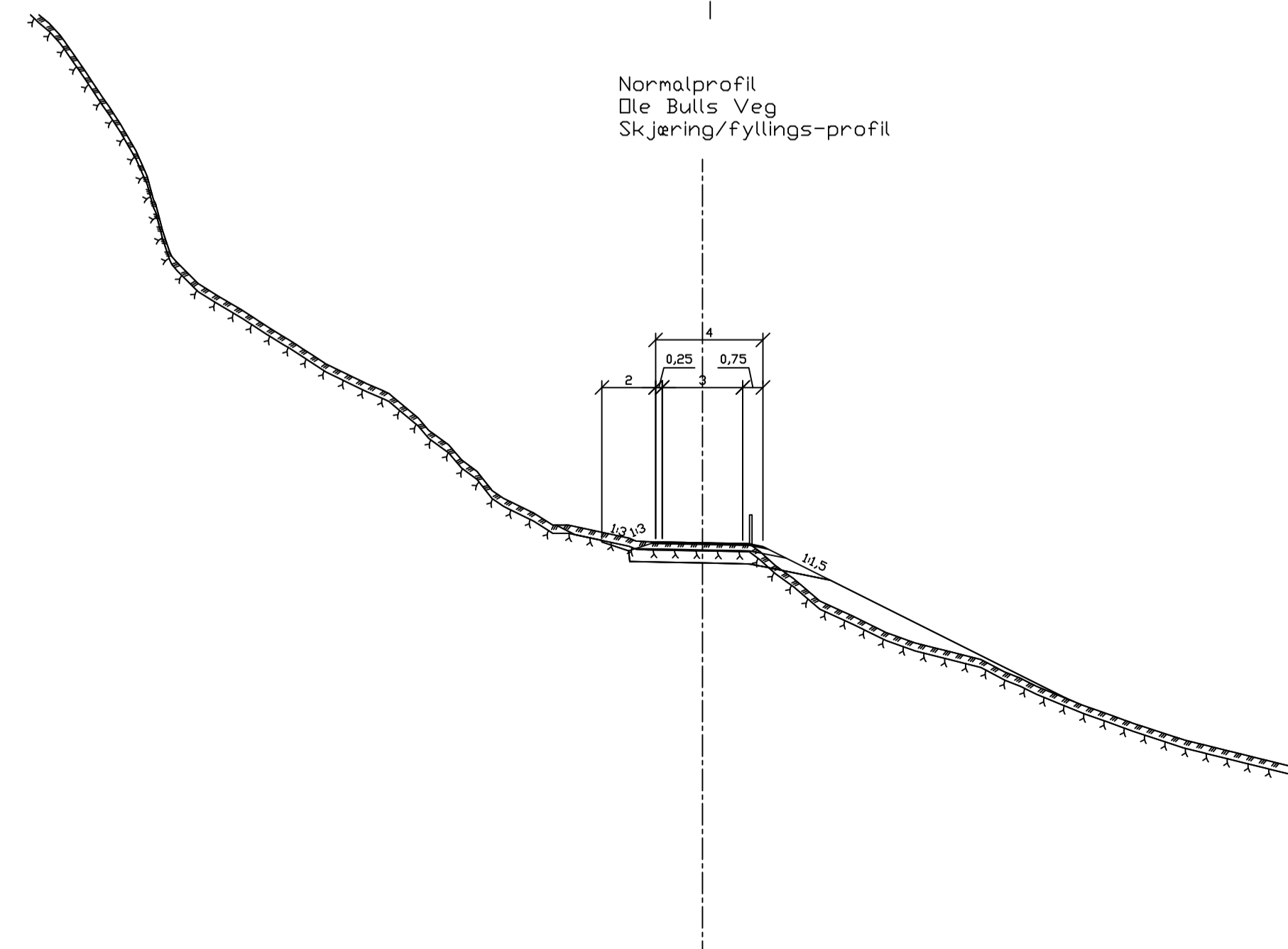
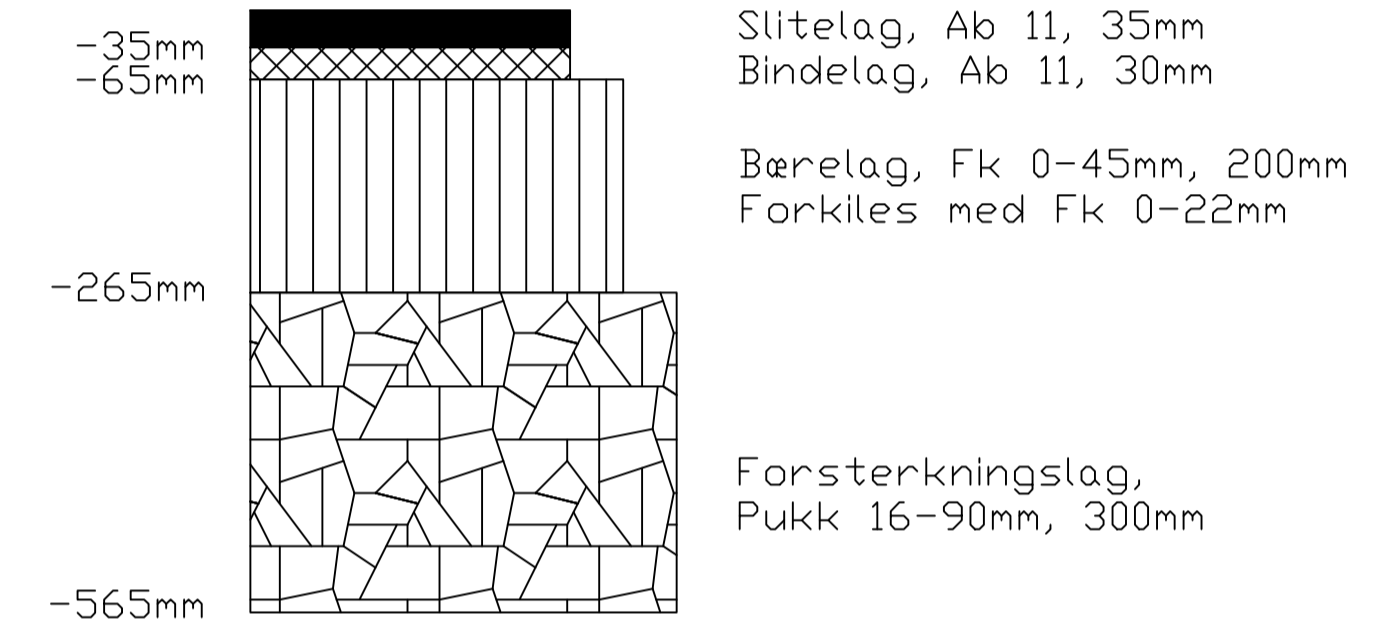

Overbygning  
Ole Bulls veg

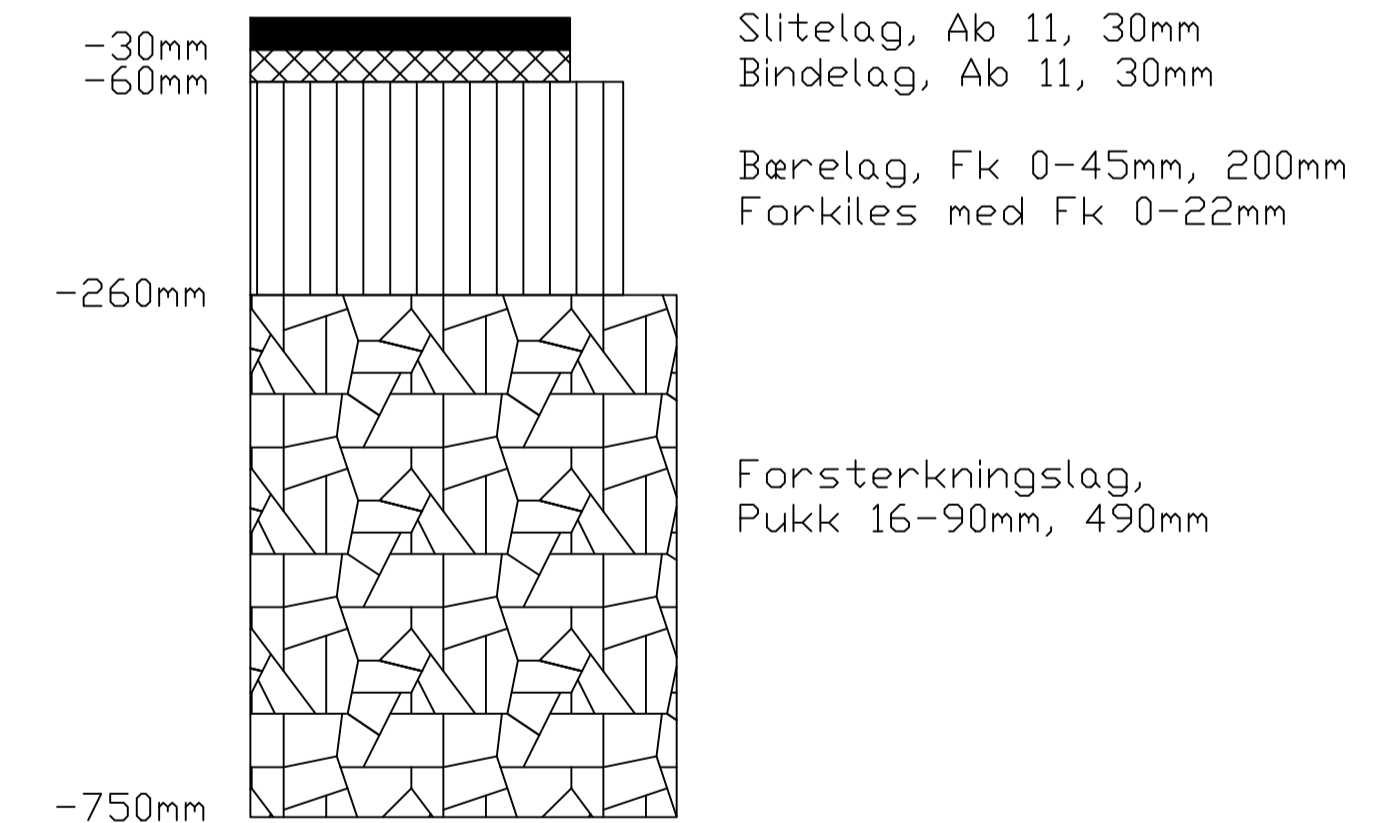

Rev.	Dato	Sign.	Revisjonen gjelder		
Oppdragsgiver			Høgskulen på Vestlandet		
Prosjekt			Tegn.	Kontr.	Godkj.
fv.5161 Åsen-Helleskaret			M.H.		B.A.N
Normalprofil og Overbygning			Dato:	18.05.21	
			Målestokk:	1:200	
			Prosjektør:	Format: A1	
			Tegningens:	Rev.	
			F002		

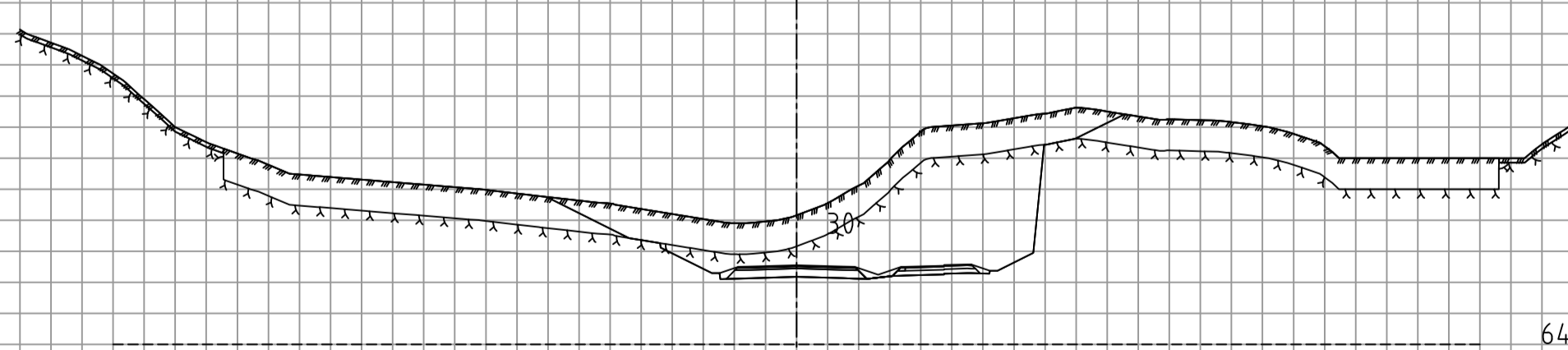
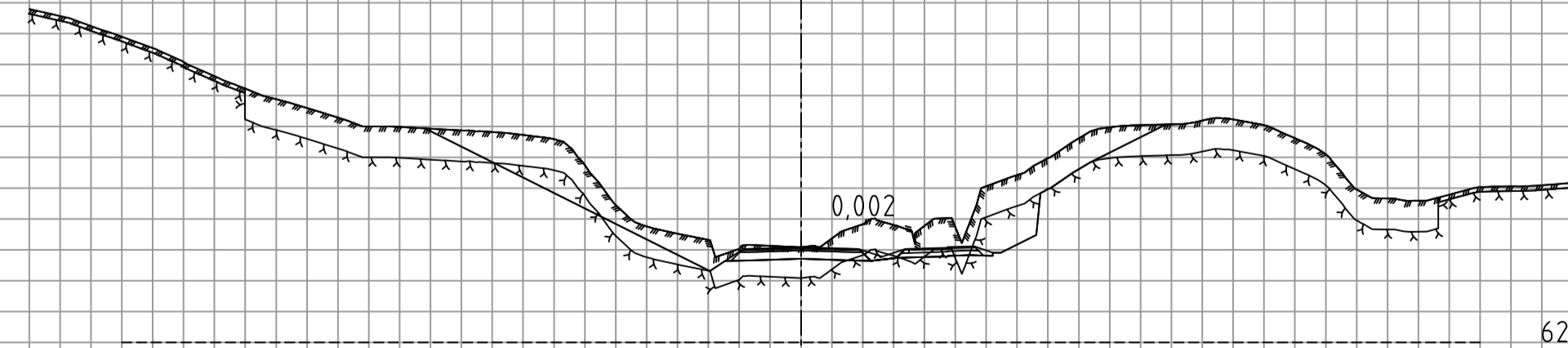
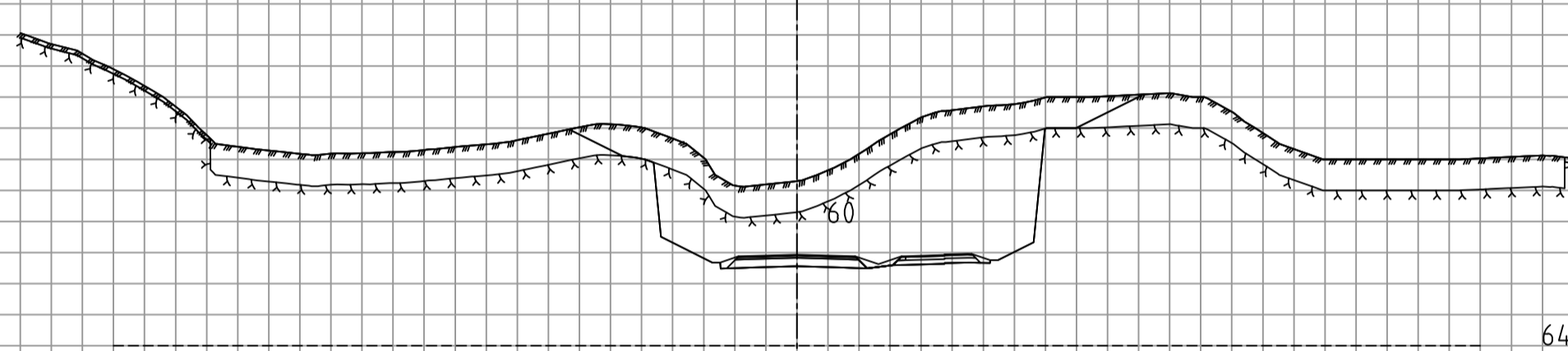
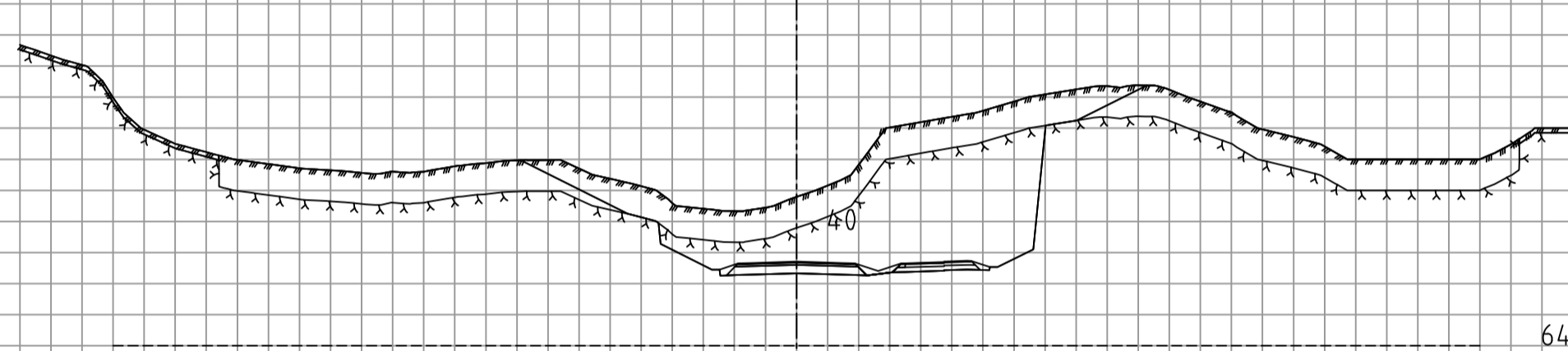
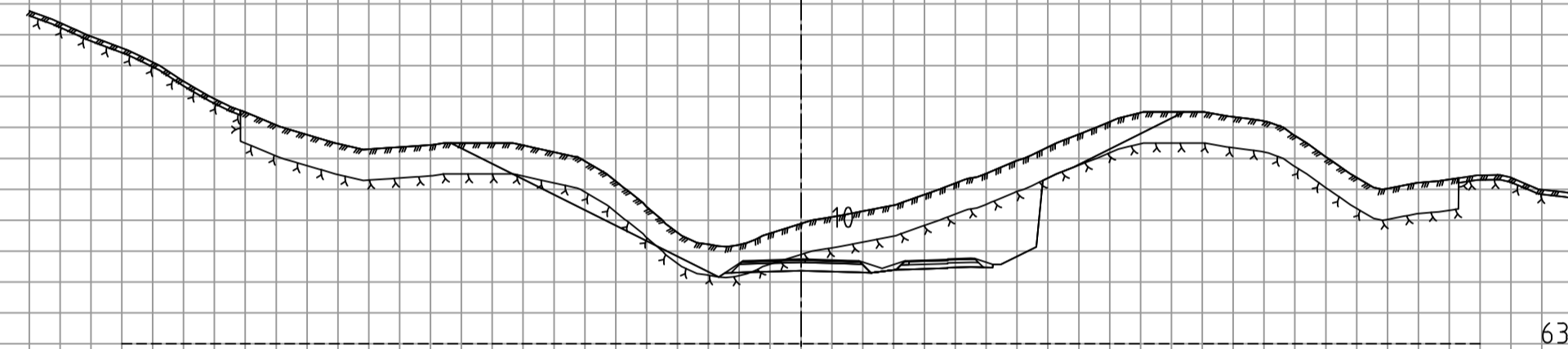
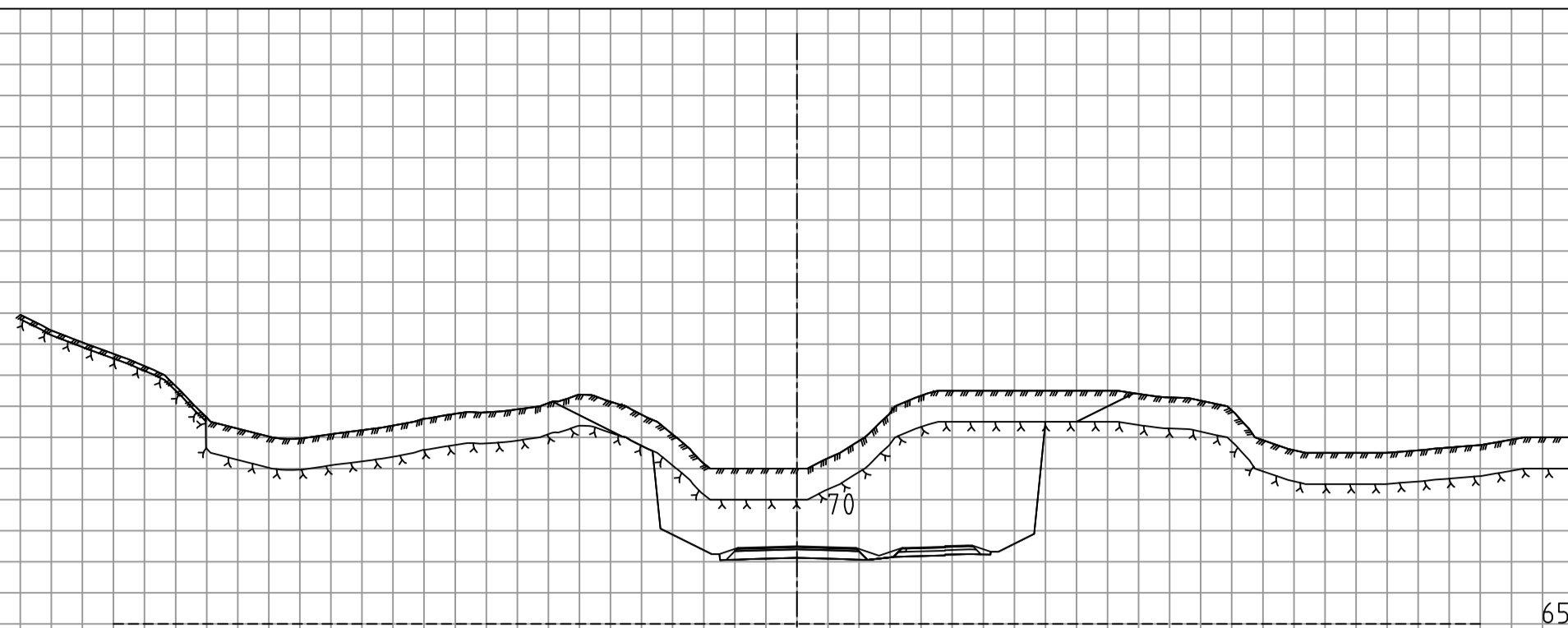
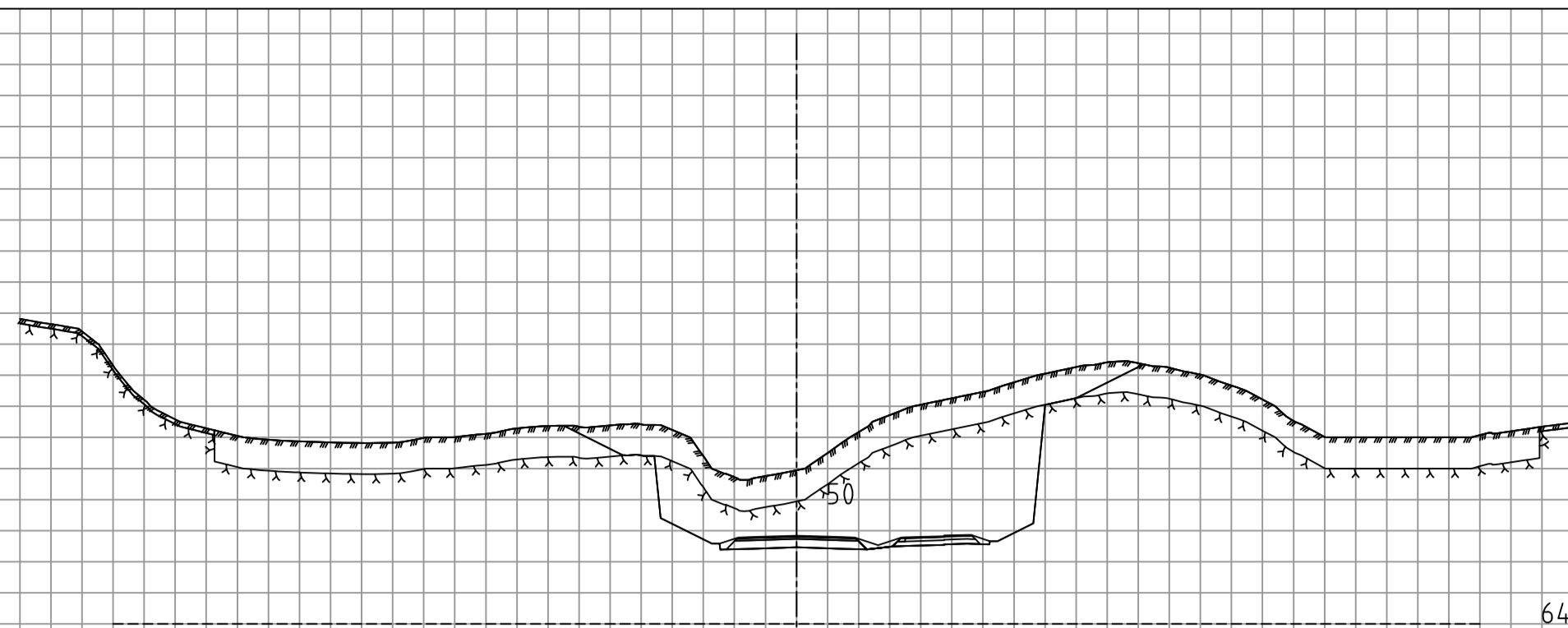
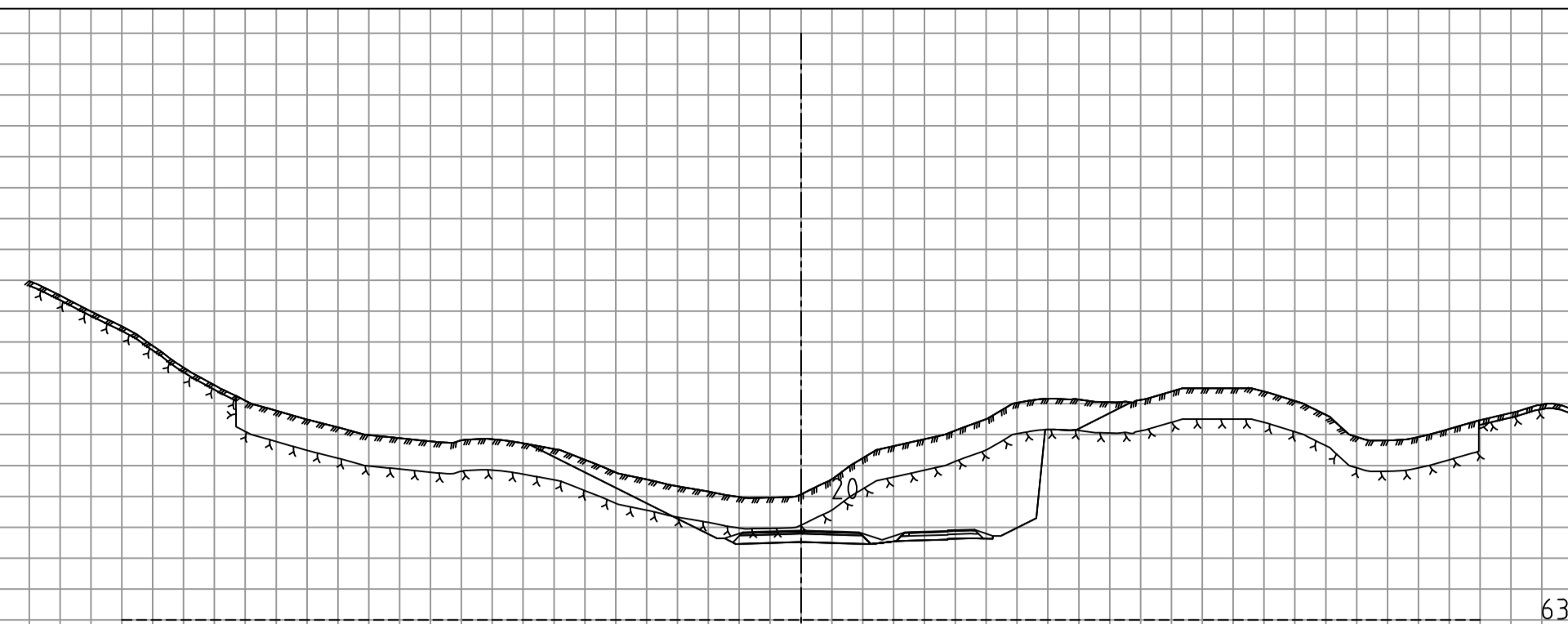

konkurransegrunnlag

Rev.	Dato	Sign.	Revisjonen gjelder		
Oppdragsgiver			Høgskulen på Vestlandet		
Prosjekt			Tegn.	Kontr.	Godkj.
fv.5161 Åsen-Helleskaret			M.H.□		B.A.N
Tverrprofiler profil 0-70			Dato: 19.05.21		
			Målestokk:	Format:	
			1:400	A1	
			Prosjektnr.		
			Tegningnr.		
			U001		
			Rev.		

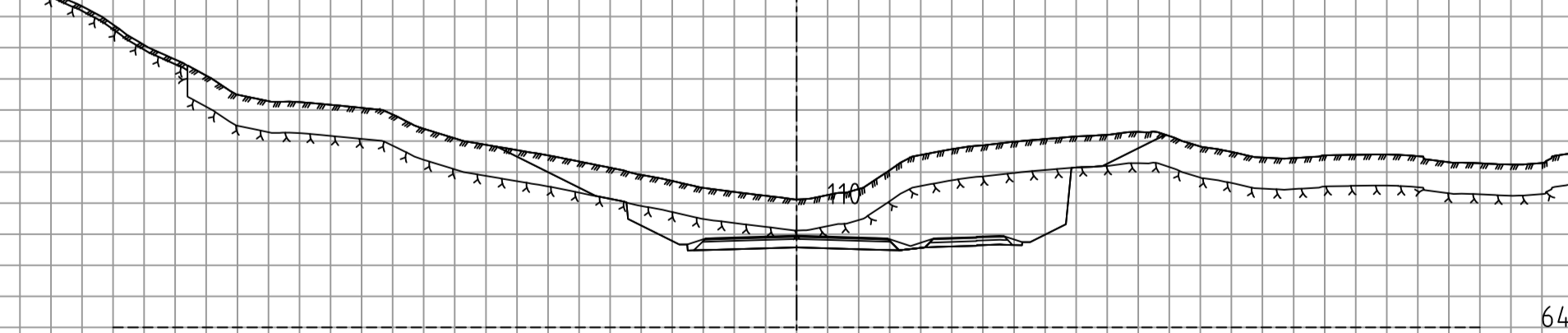
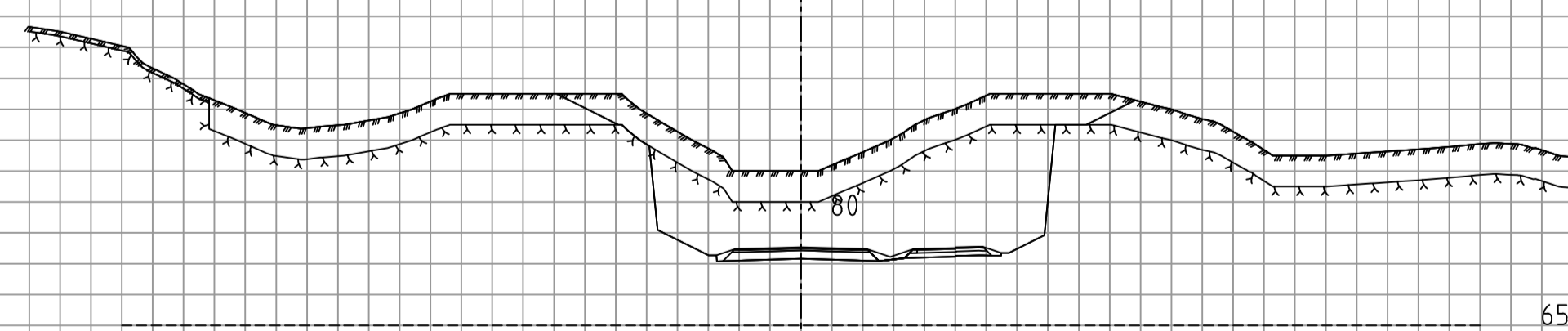
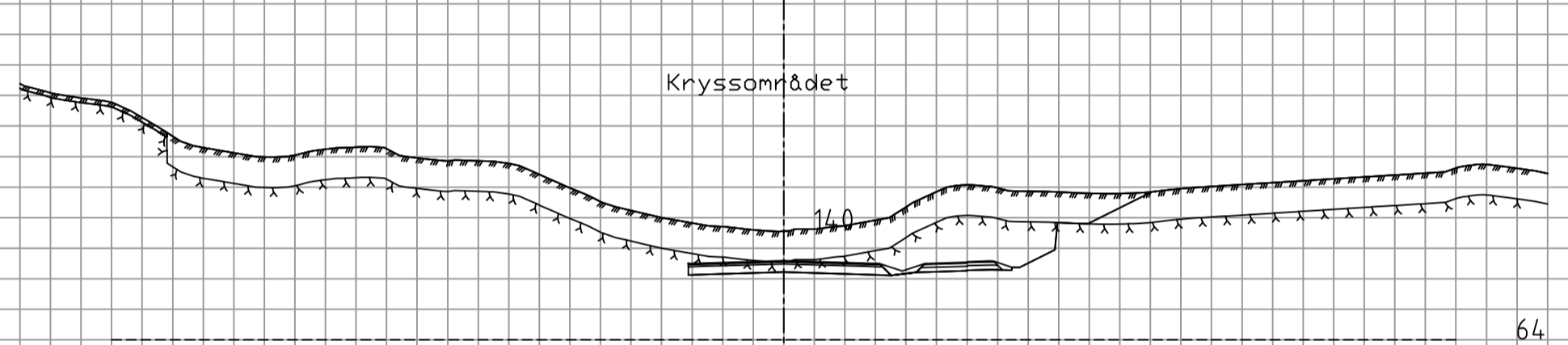
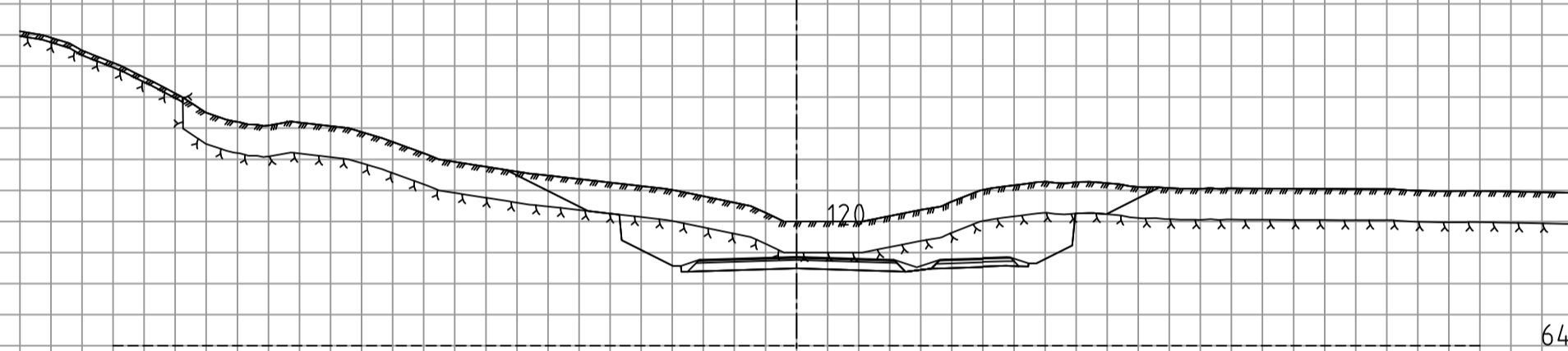
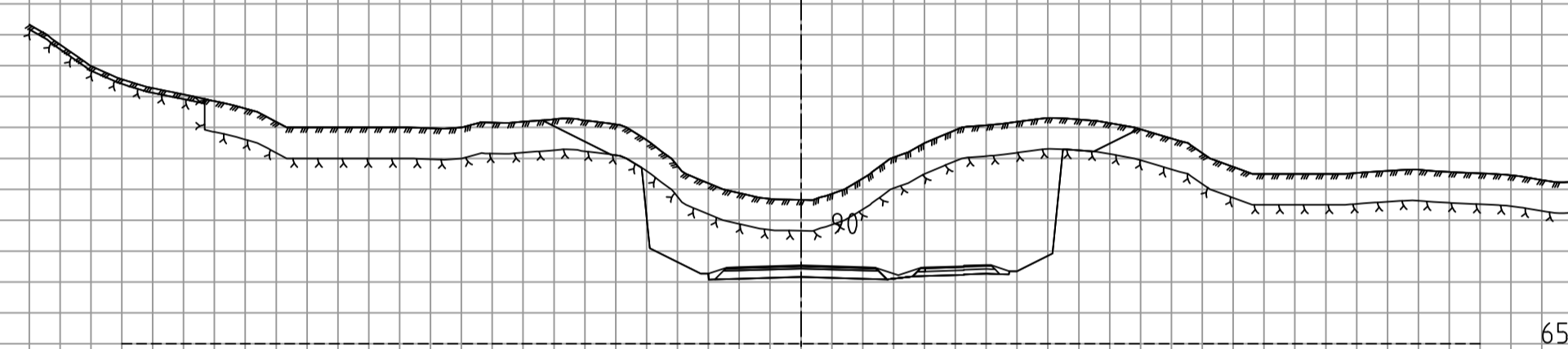
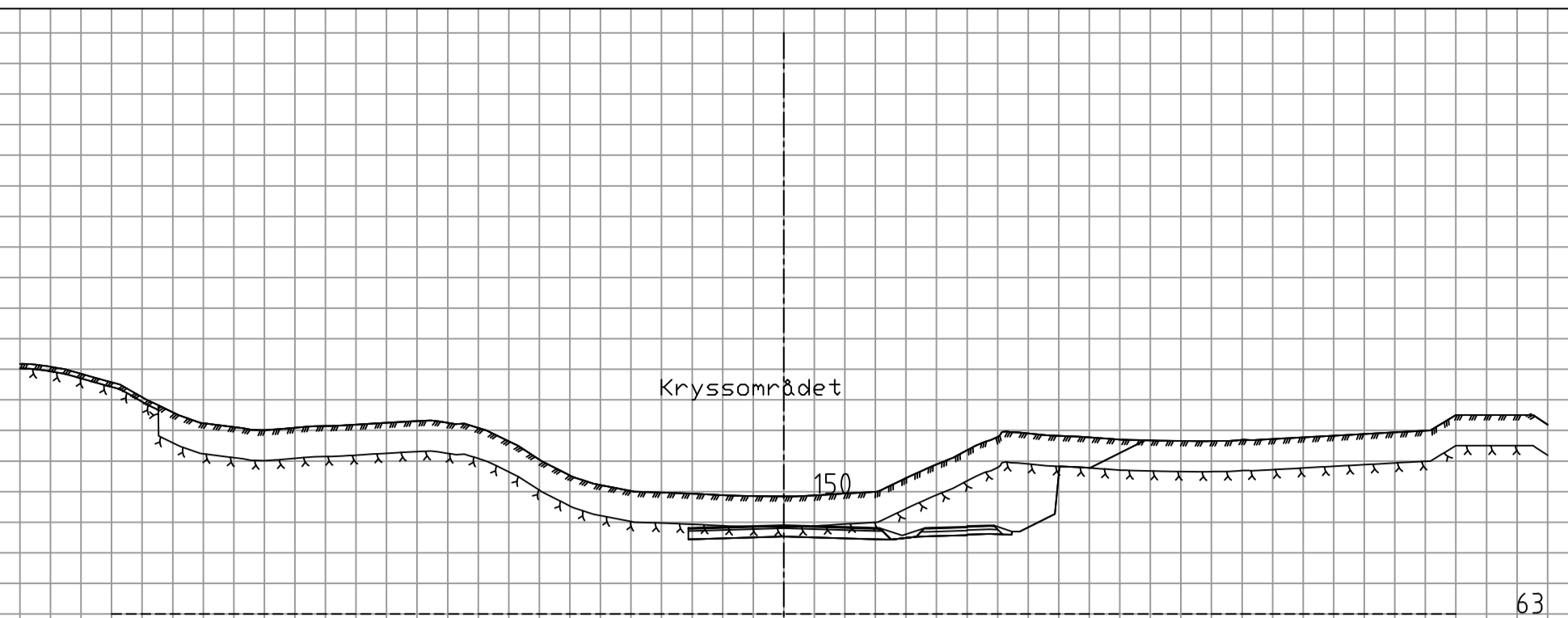
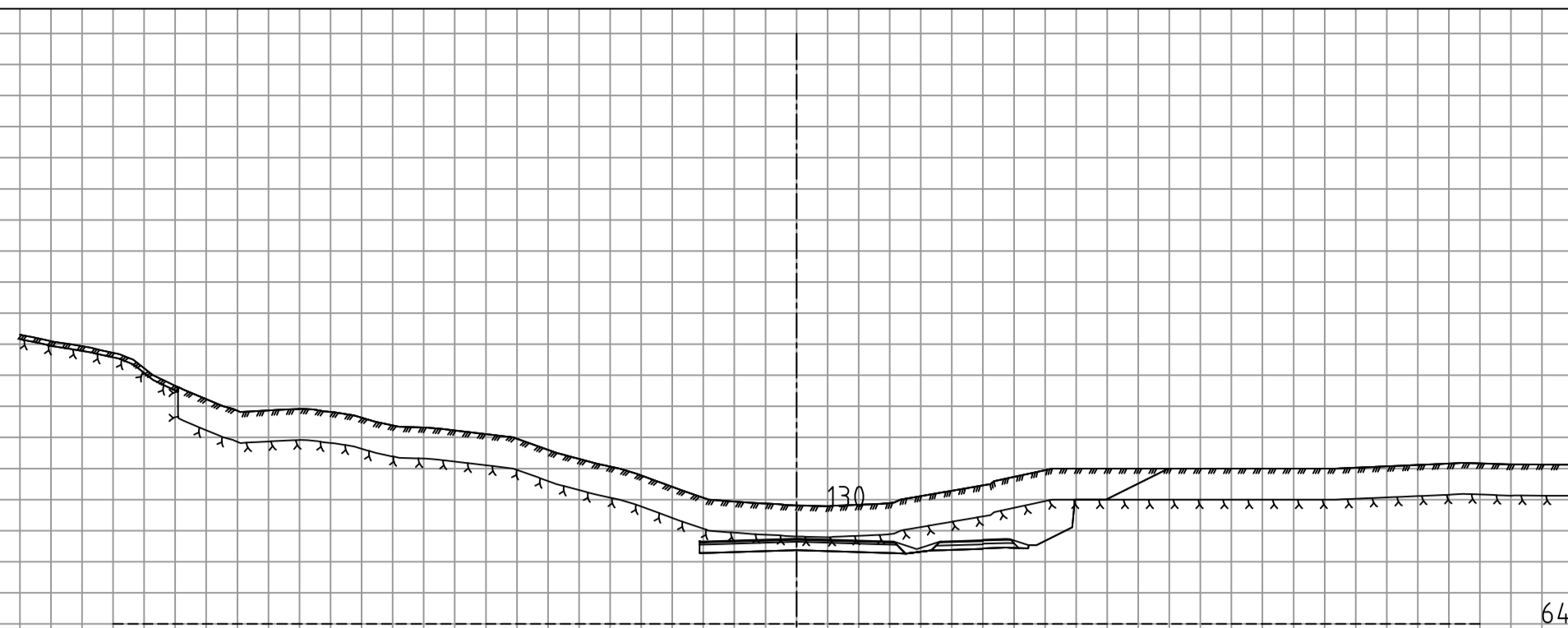
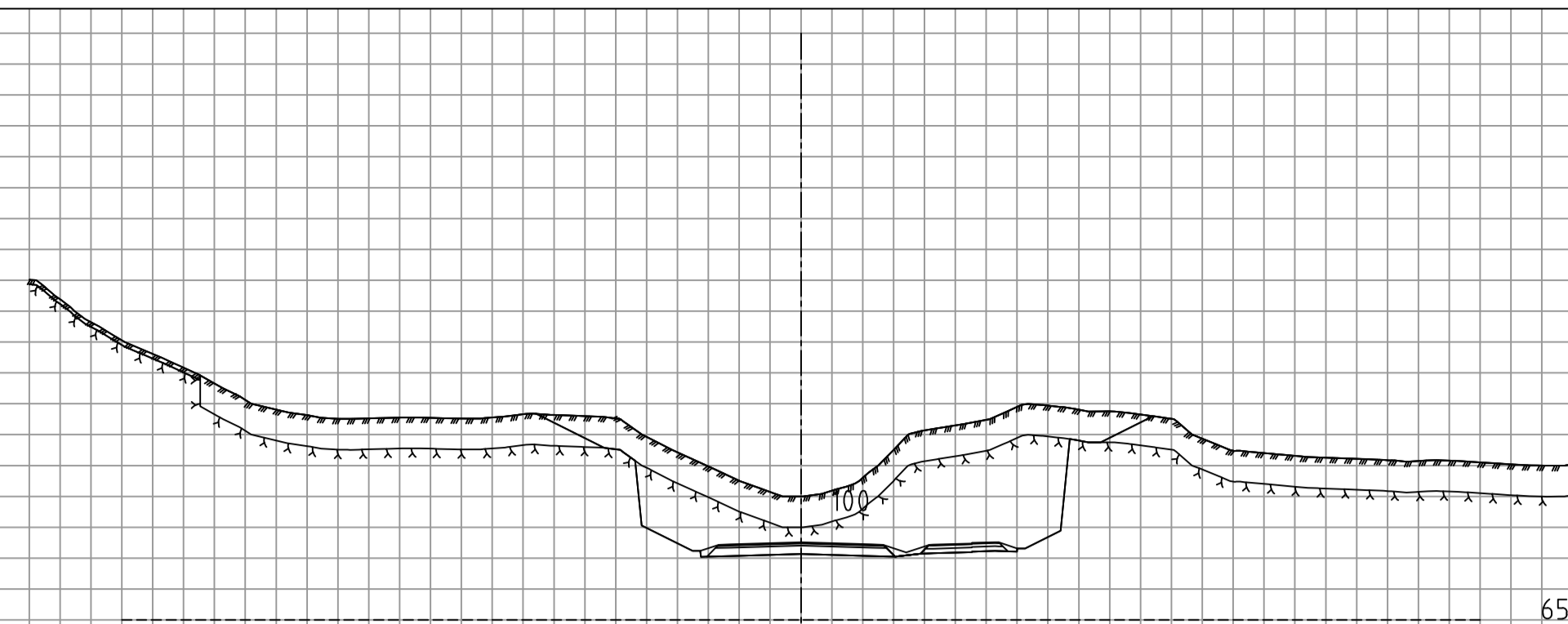

konkurransegrunnlag

Rev.	Dato	Sign.	Revisjonen gjelder		
Oppdragsgiver			Høgskulen på Vestlandet		
Prosjekt			Tegn.	Kontr.	Godkj.
fv.5161 Åsen-Helleskaret			M.H.□		B.A.N
Tverrprofiler profil 80-150			Dato: 19.05.21		
			Målestokk:	Format:	
			1:400	A1	
			Prosjektnr.		
			Tegninger:		
			U002		
			Rev.		

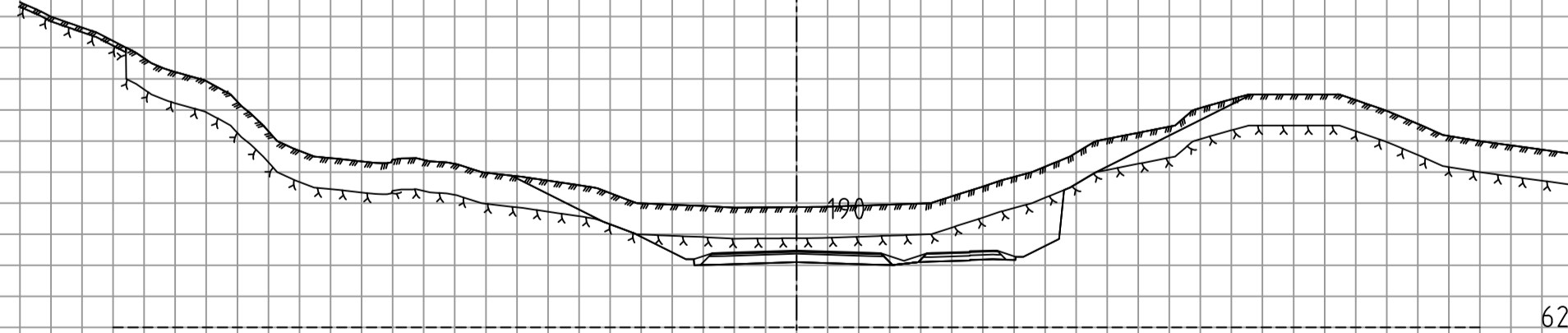
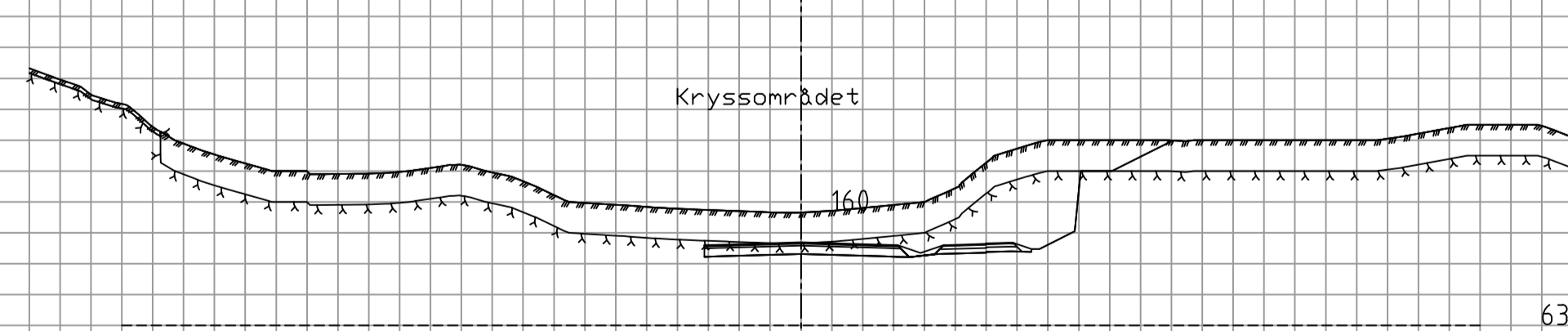
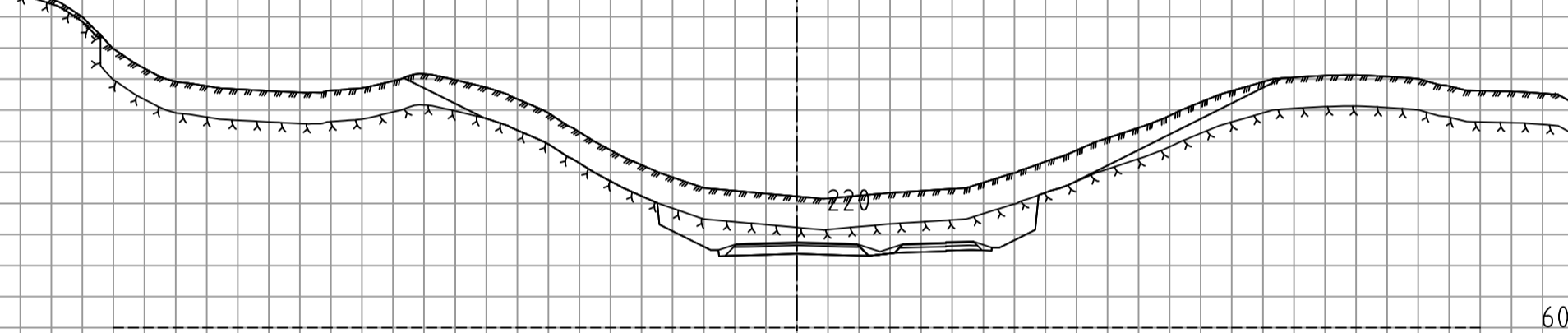
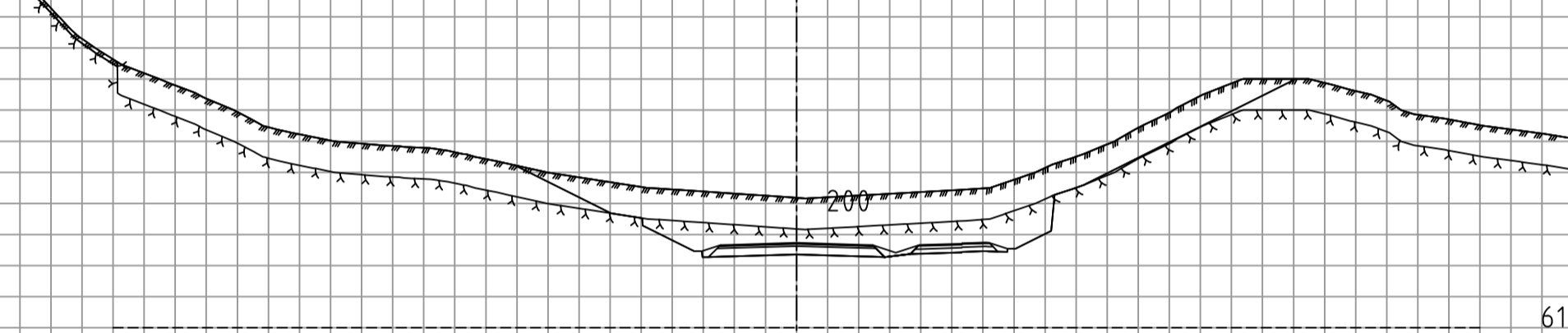
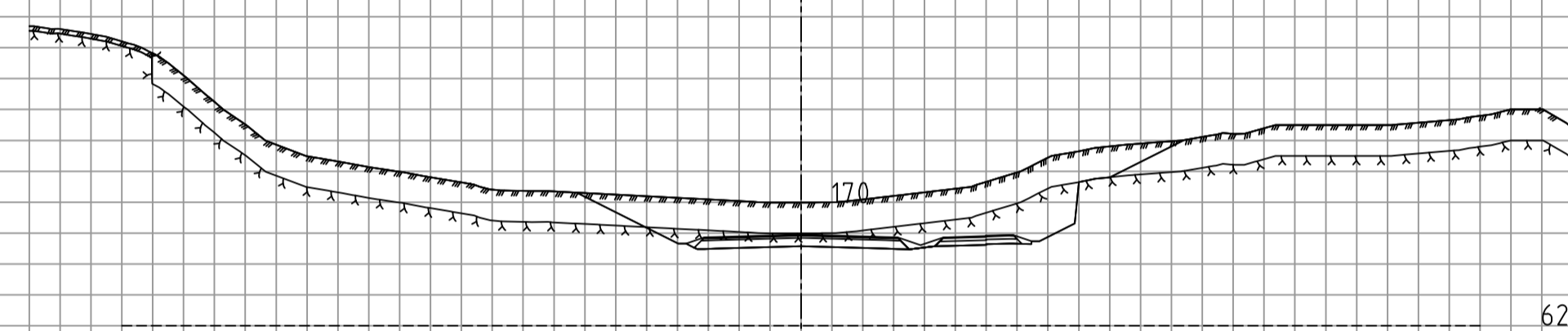
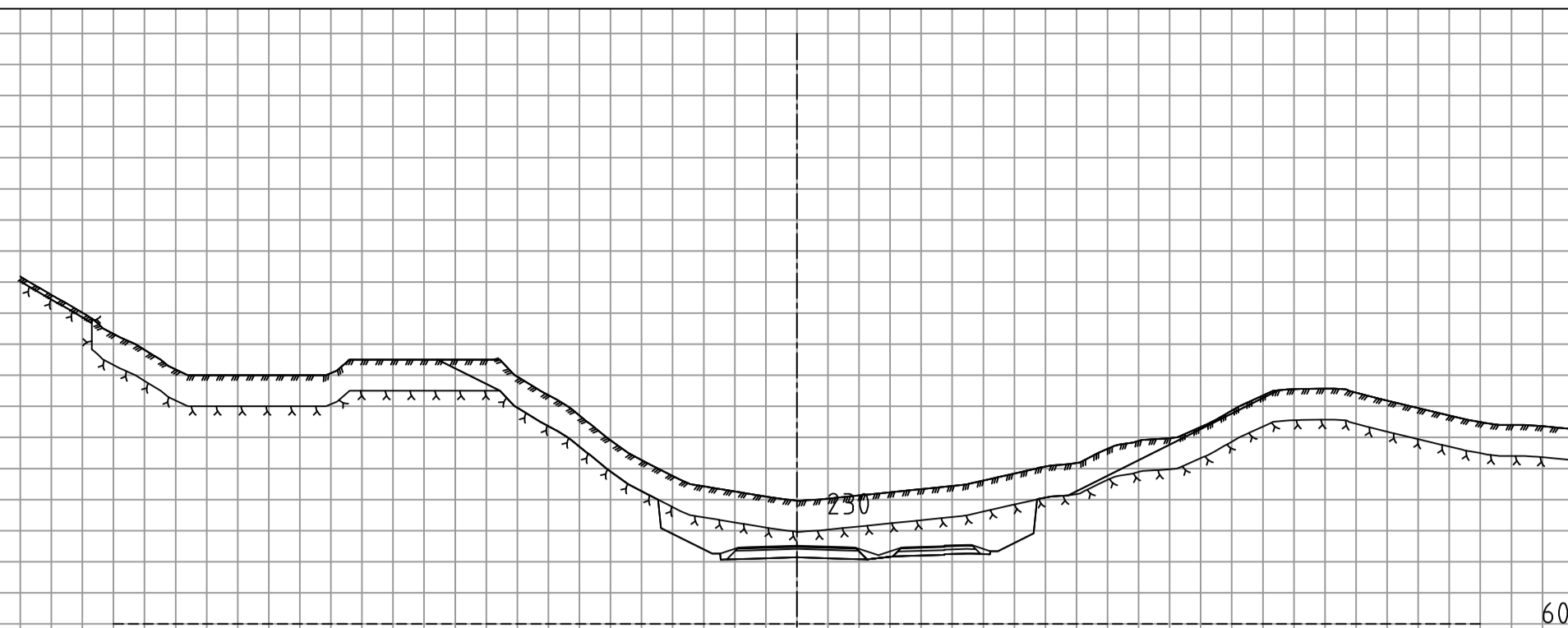
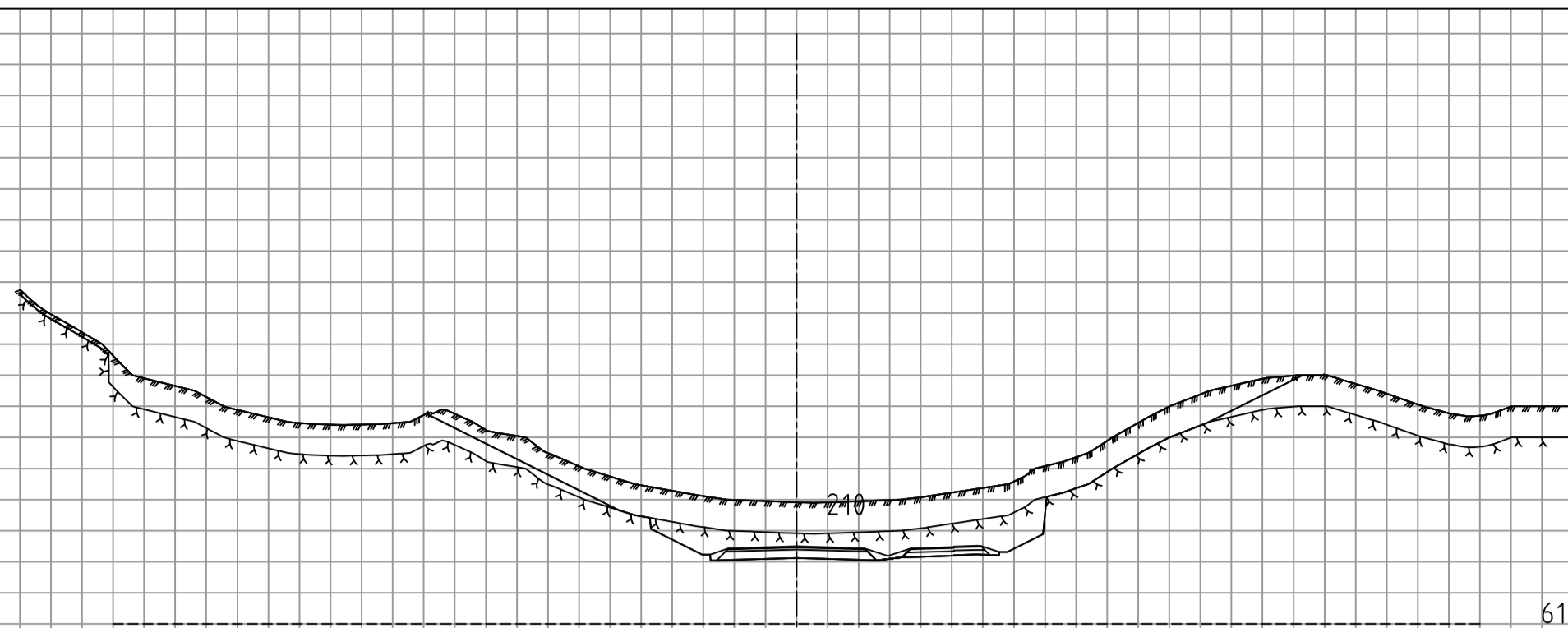
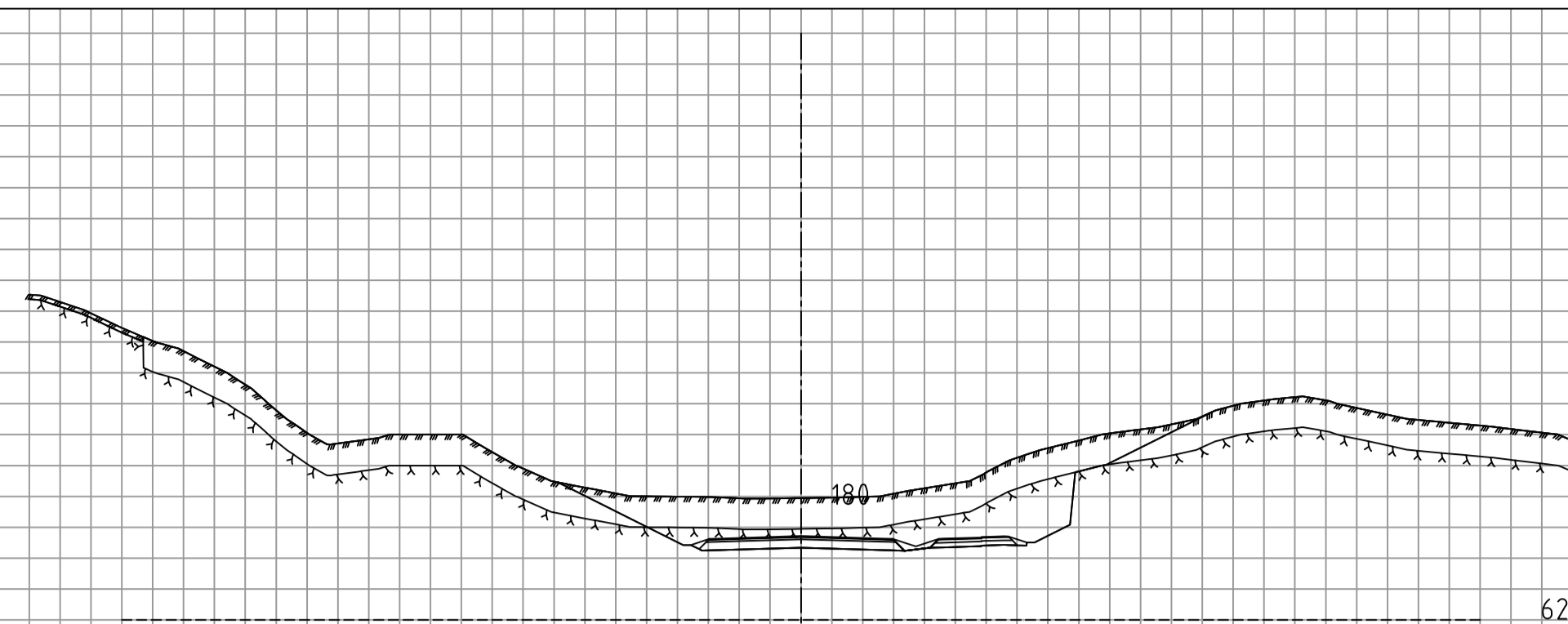

konkurransegrunnlag

Rev.	Dato	Sign.	Revisjonen gjelder		
Oppdragsgiver			Høgskulen på Vestlandet		
Prosjekt			Tegn.	Kontr.	Godkj.
fv.5161 Åsen-Helleskaret			M.H.□		B.A.N
Tverrprofiler profil 160-230			Dato: 19.05.21		
			Målestokk:	Format:	
			1:400	A1	
			Prosjektnr.		
			Tegningnr.		
			U003		
			Rev.		

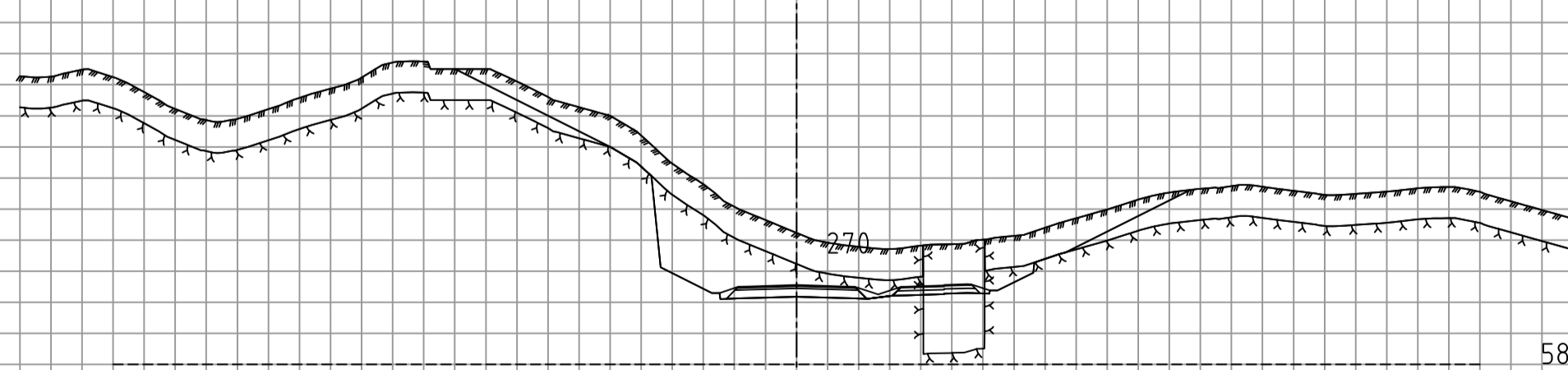
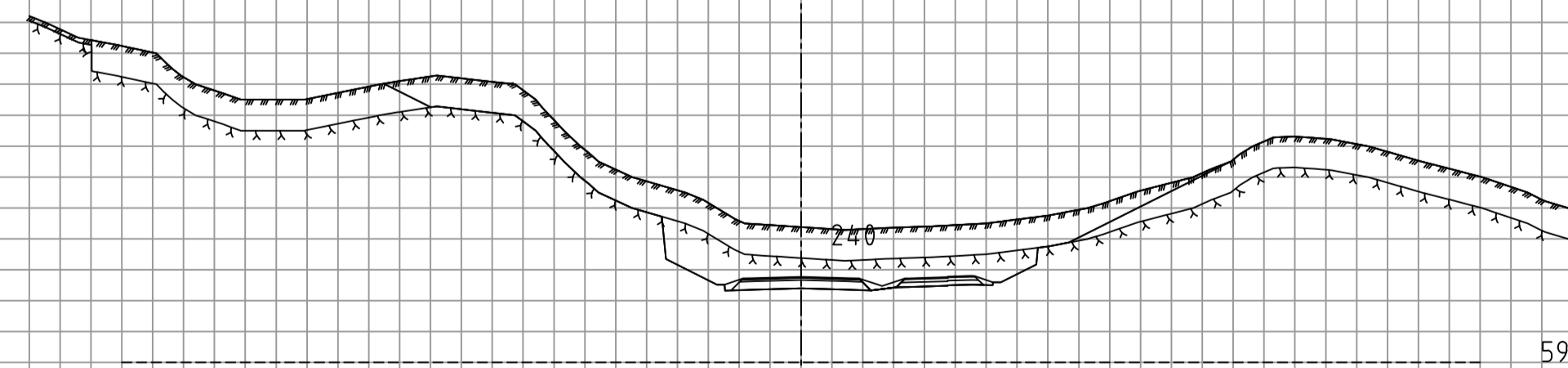
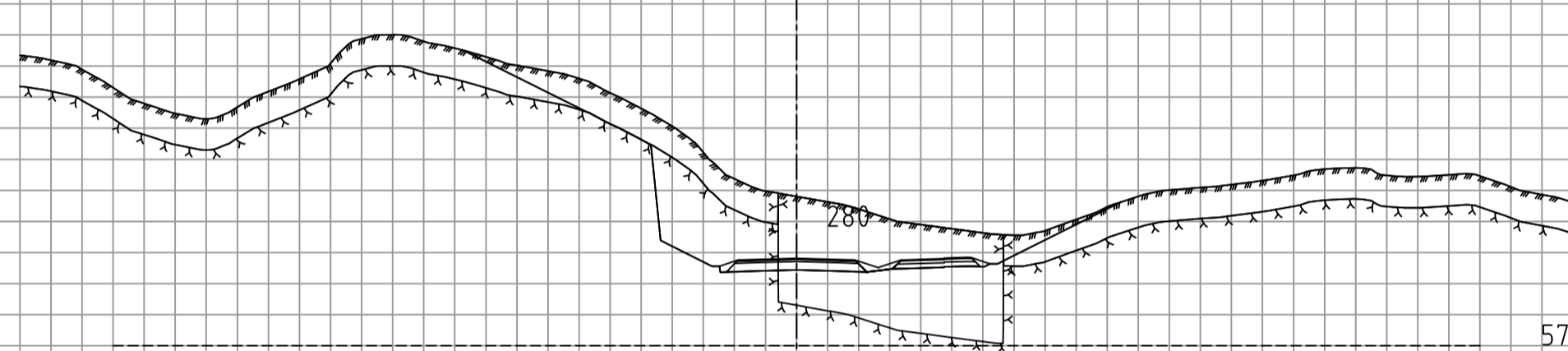
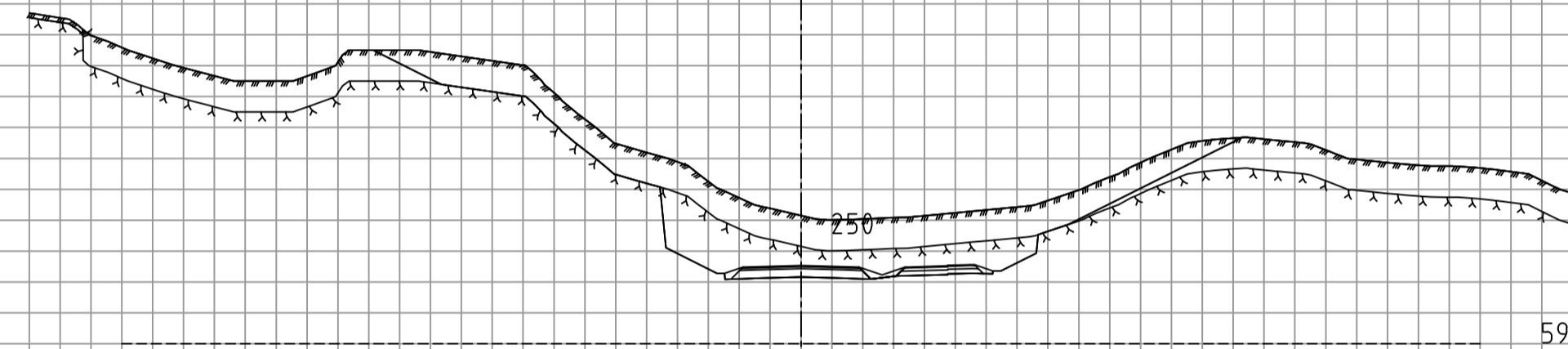
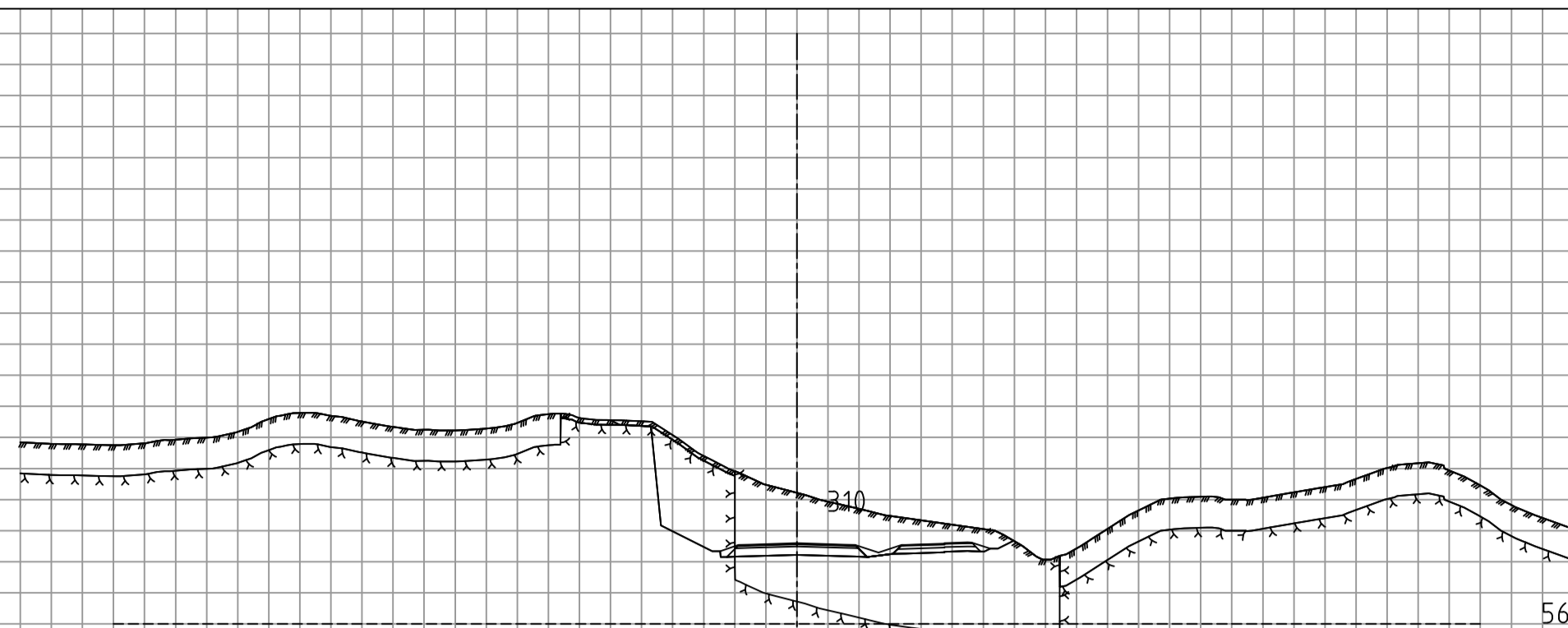
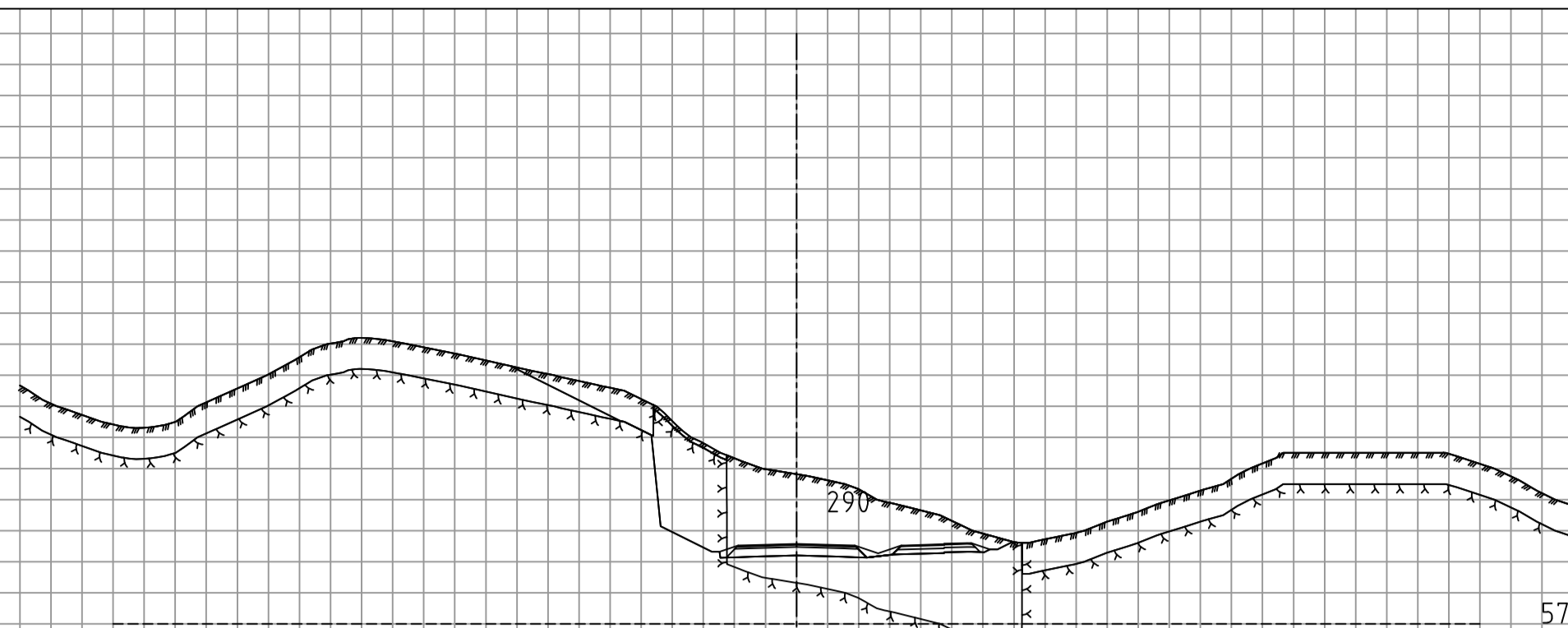
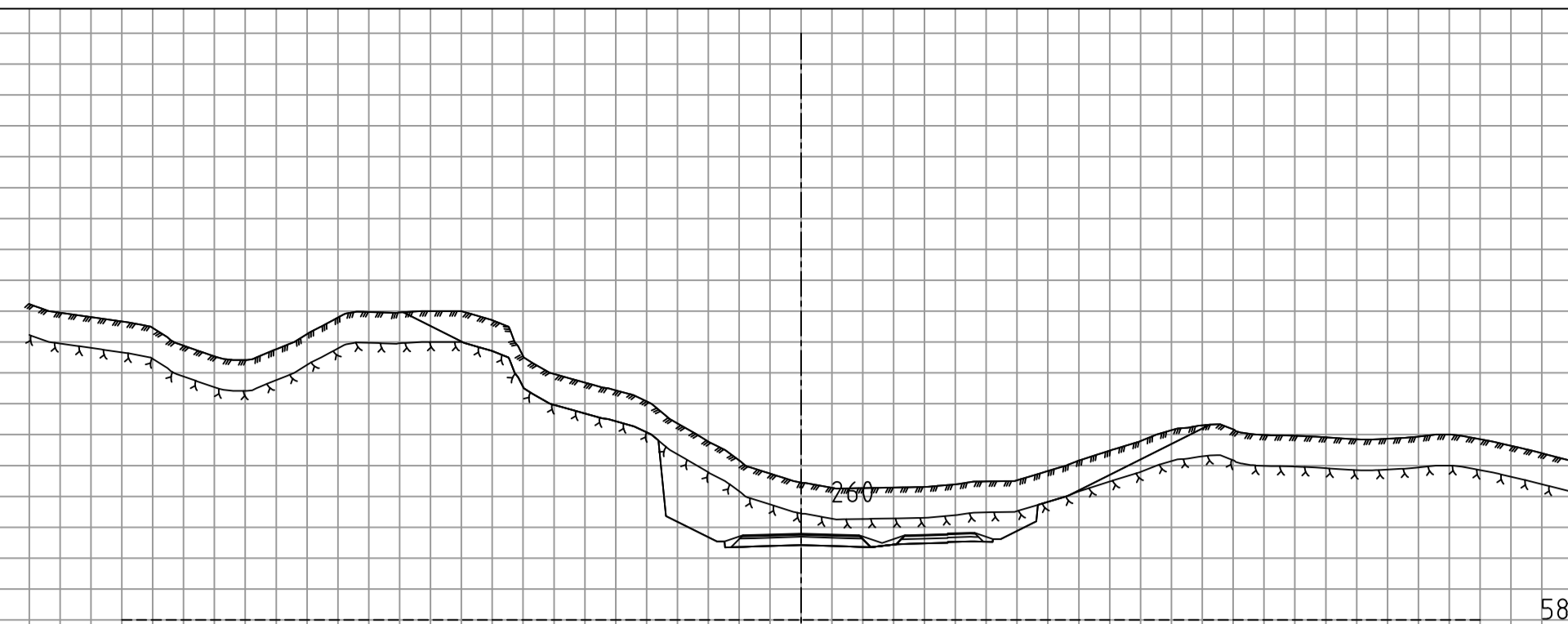

konkurransegrunnlag

Rev.	Dato	Sign.	Revisjonen gjelder		
Oppdragsgiver			Høgskulen på Vestlandet		
Prosjekt			Tegn.	Kontr.	Godkj.
fv.5161 Åsen-Helleskaret			M.H.□		B.A.N
Tverrprofiler profil 240-310			Dato: 19.05.21		
			Målestokk:	Format:	
			1:400	A1	
			Prosjektnr.		
			Tegningsnr.	Rev.	
			U004		

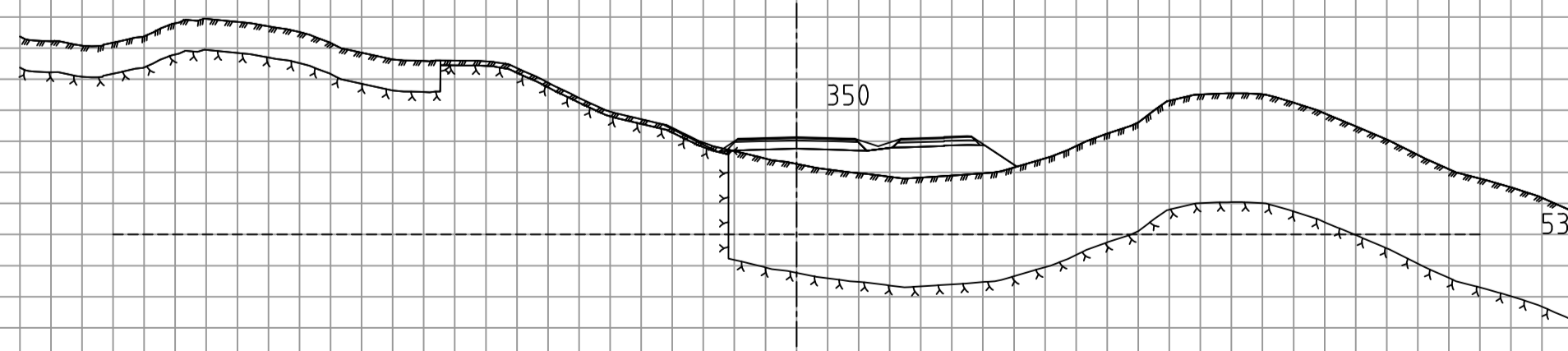
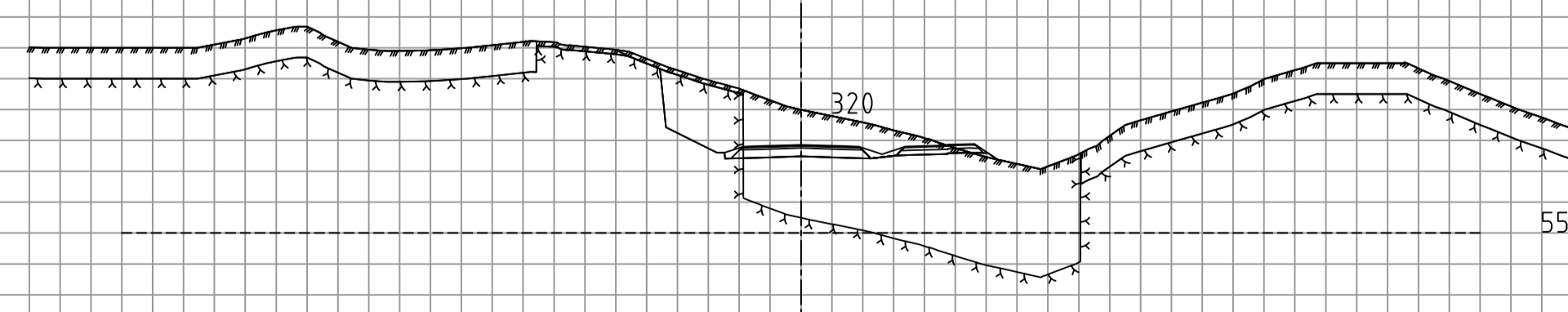
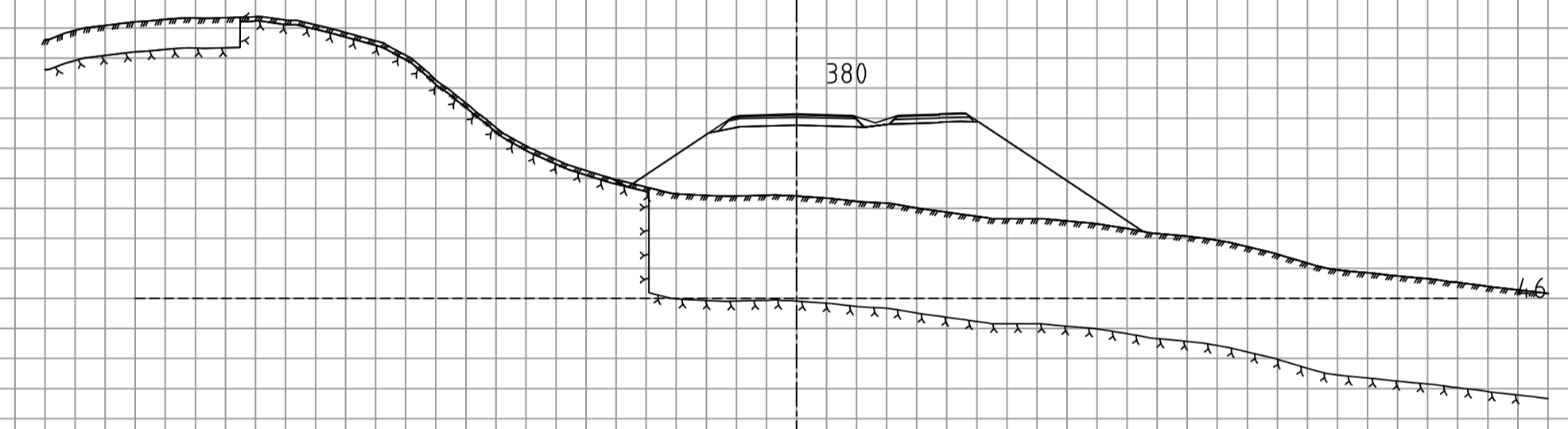
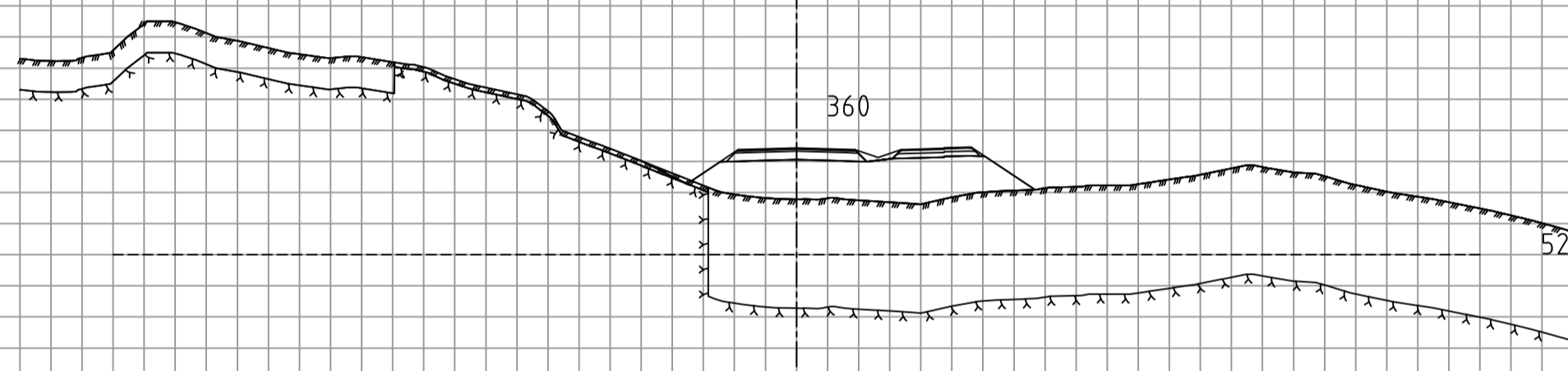
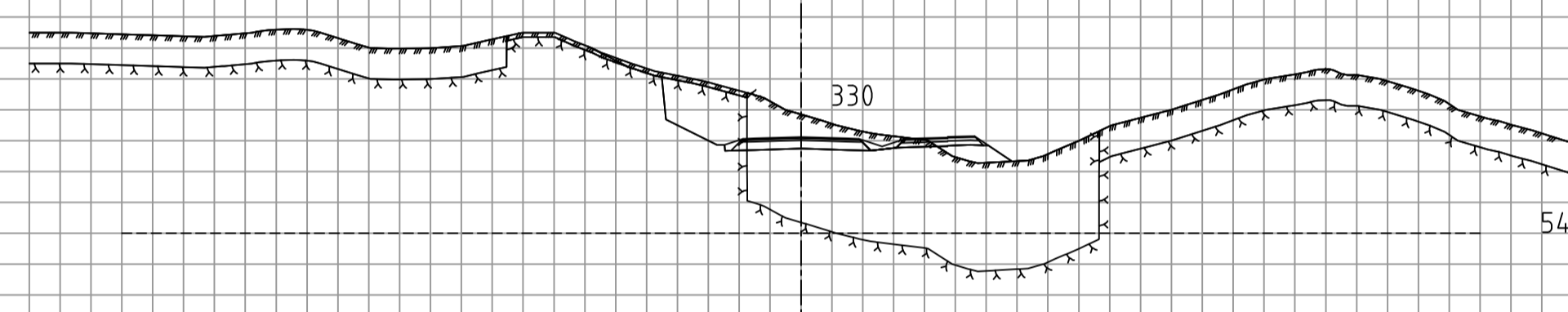
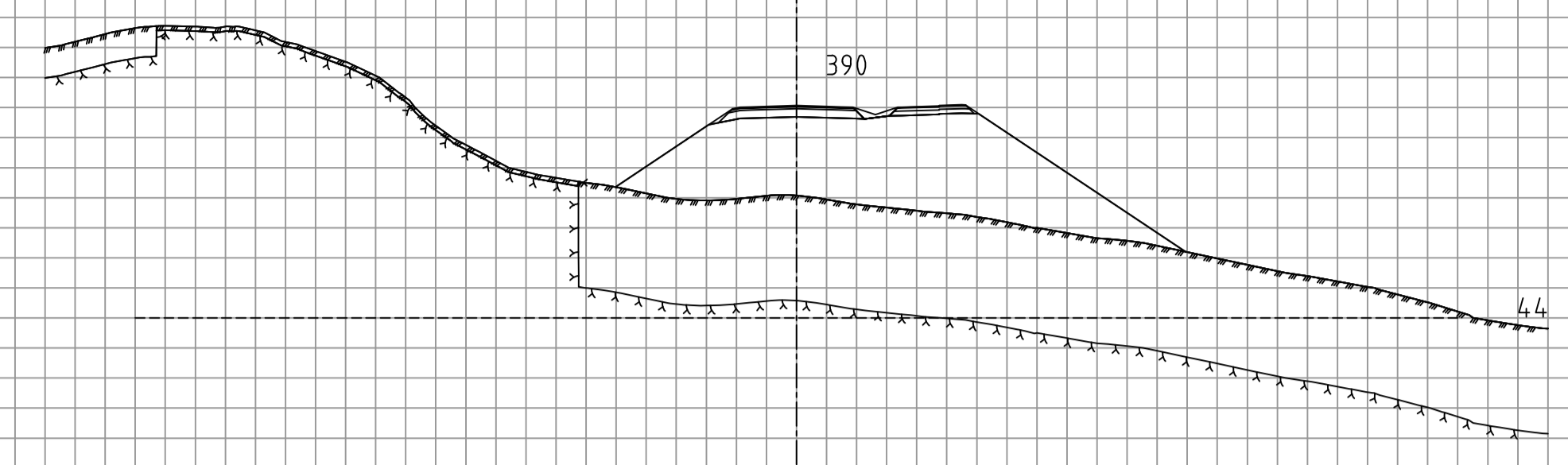
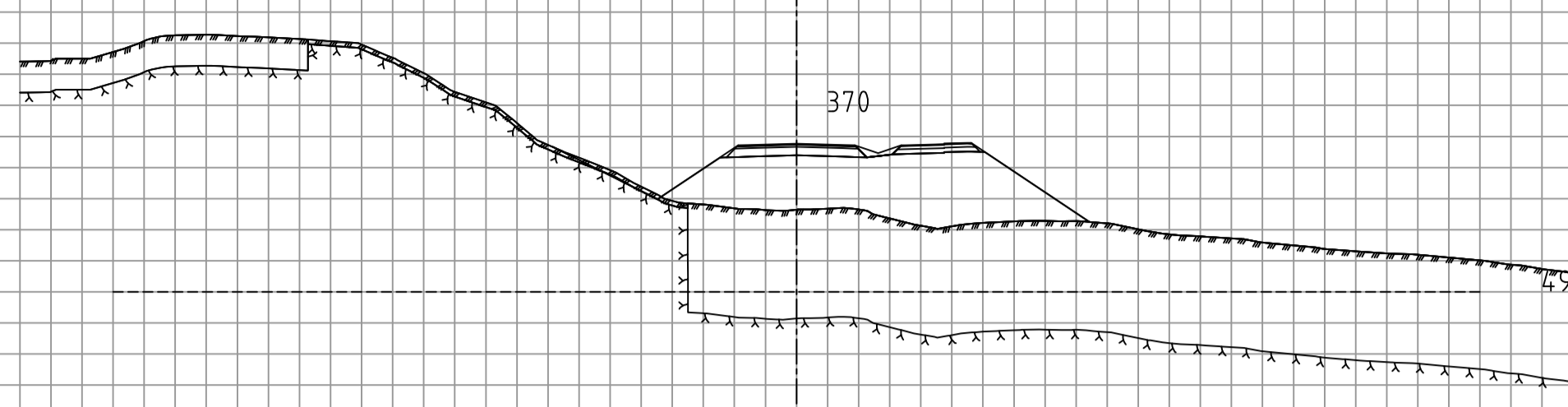
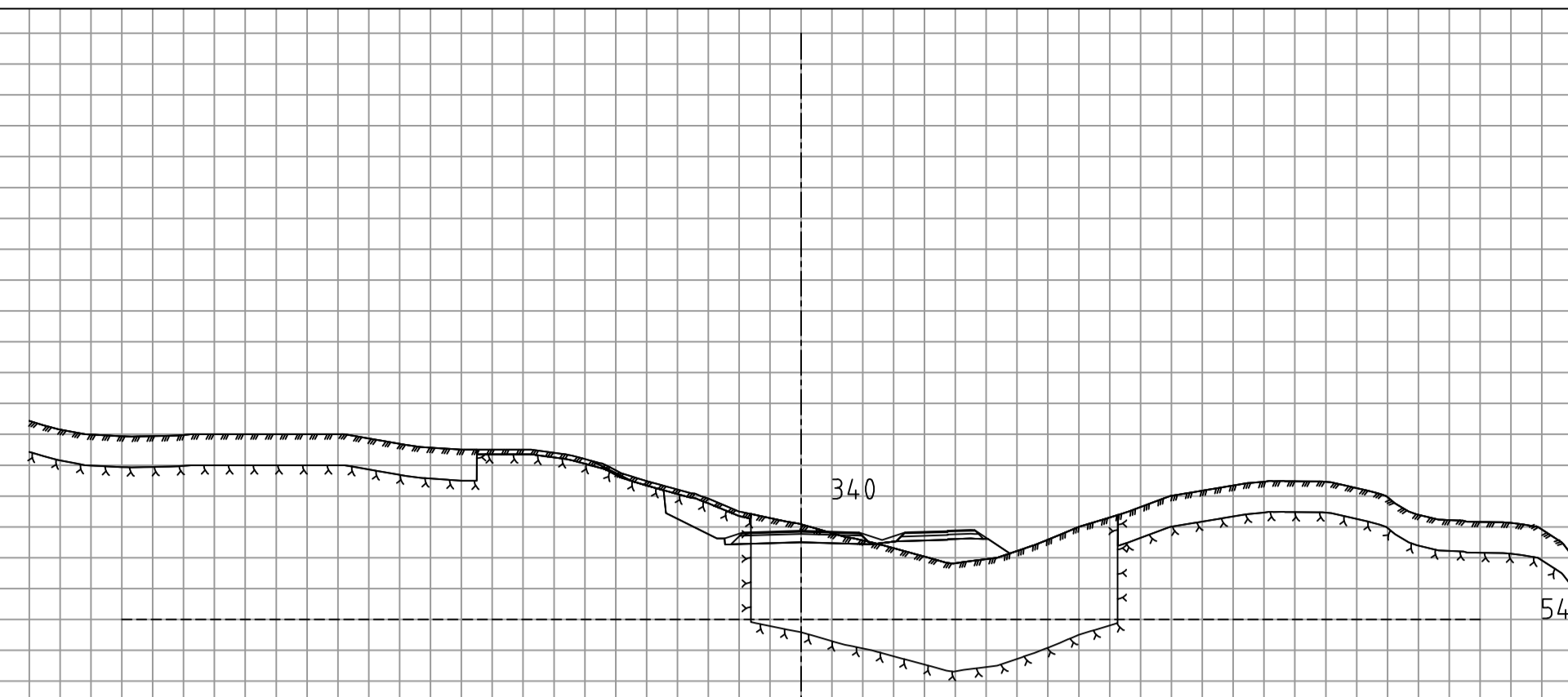

konkurransegrunnlag

Rev.	Dato	Sign.	Revisjonen gjelder		
Oppdragsgiver			Høgskulen på Vestlandet		
Prosjekt			Tegn.	Kontr.	Godkj.
fv.5161 Åsen-Helleskaret			M.H.□		B.A.N
Tverrprofiler profil 320-390			Dato:		19.05.21
			Målestokk:	Format:	
			1:400	A1	
			Tegningnr.		
			U005		
			Rev.		

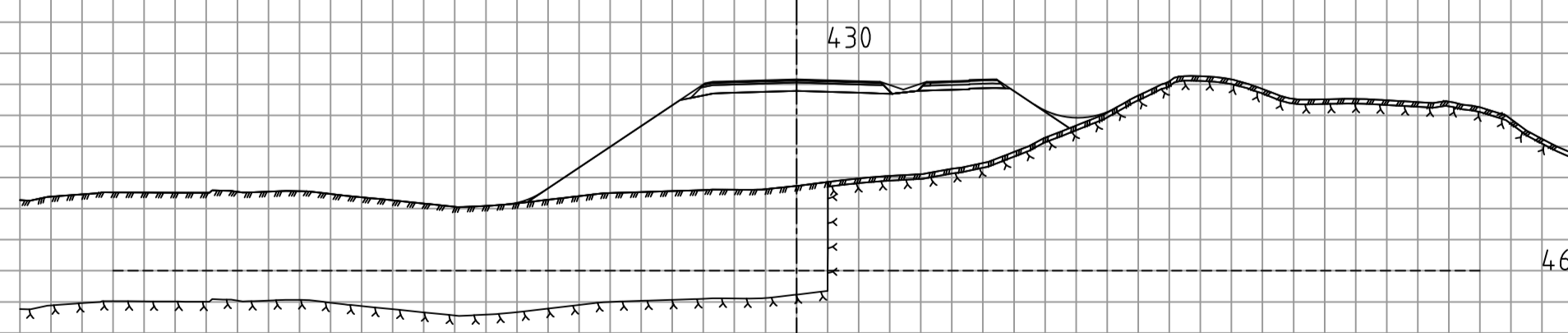
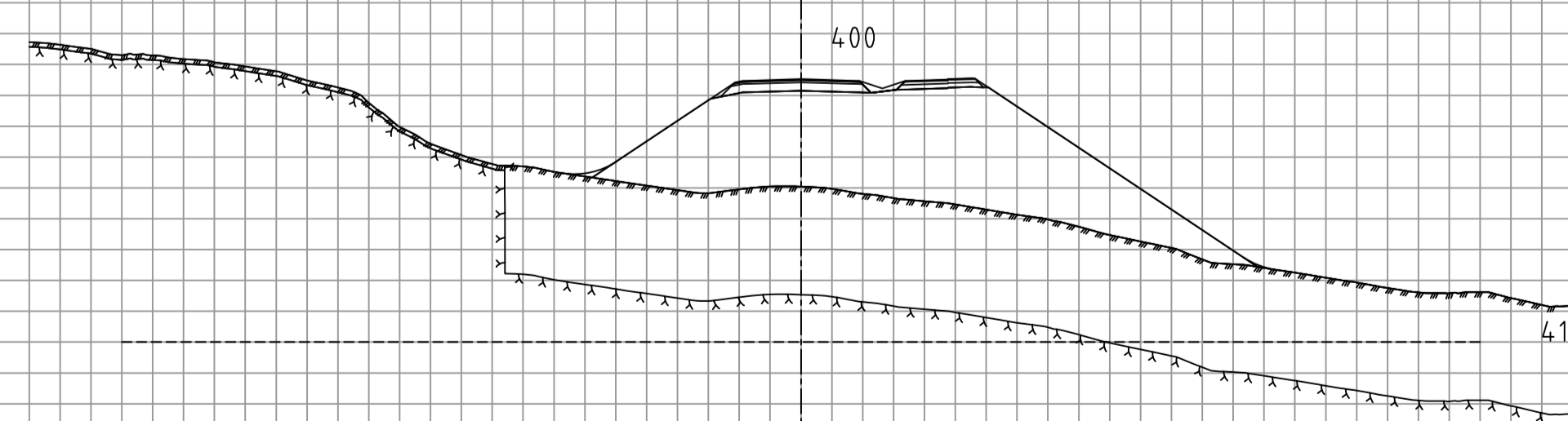
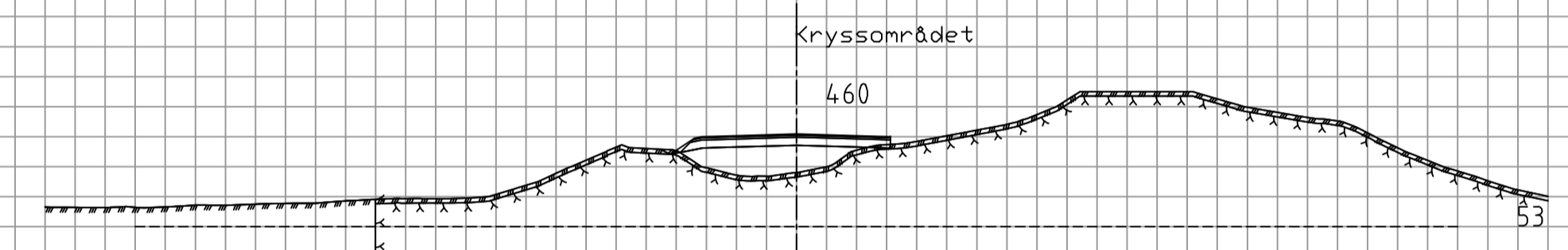
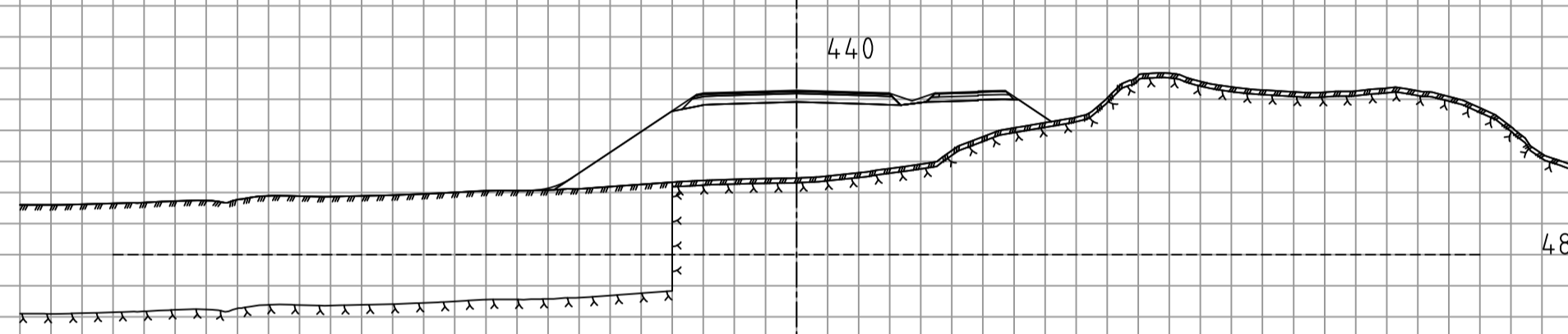
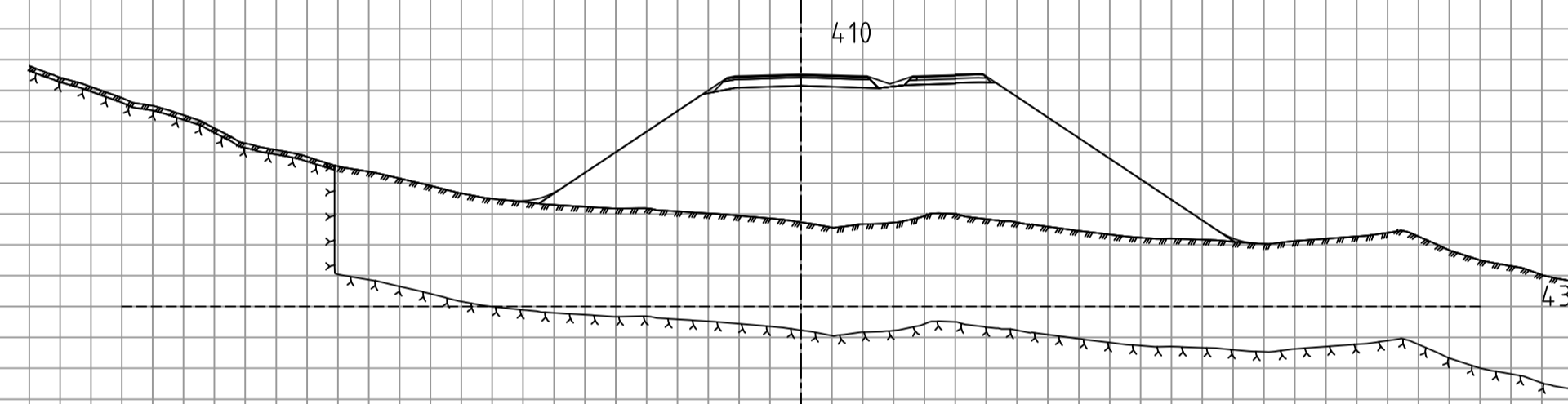
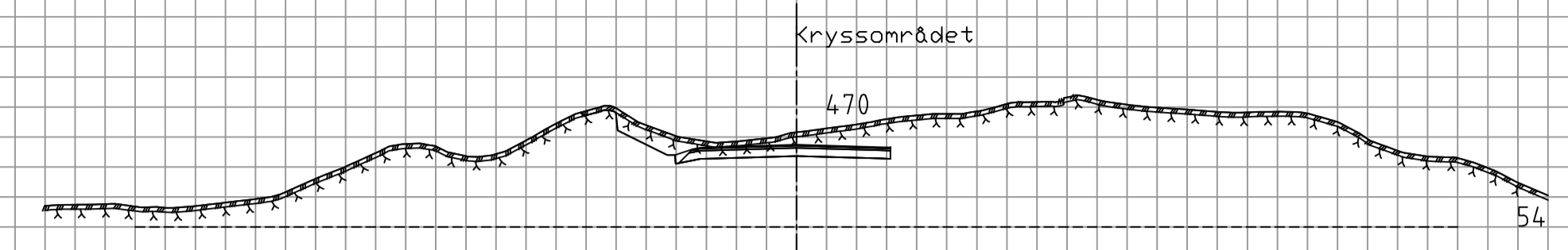
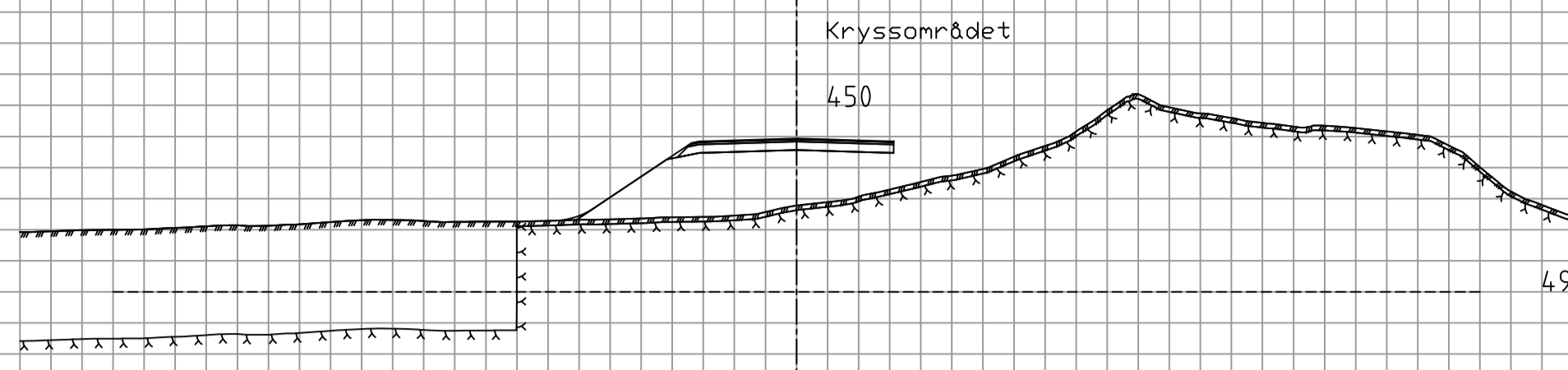
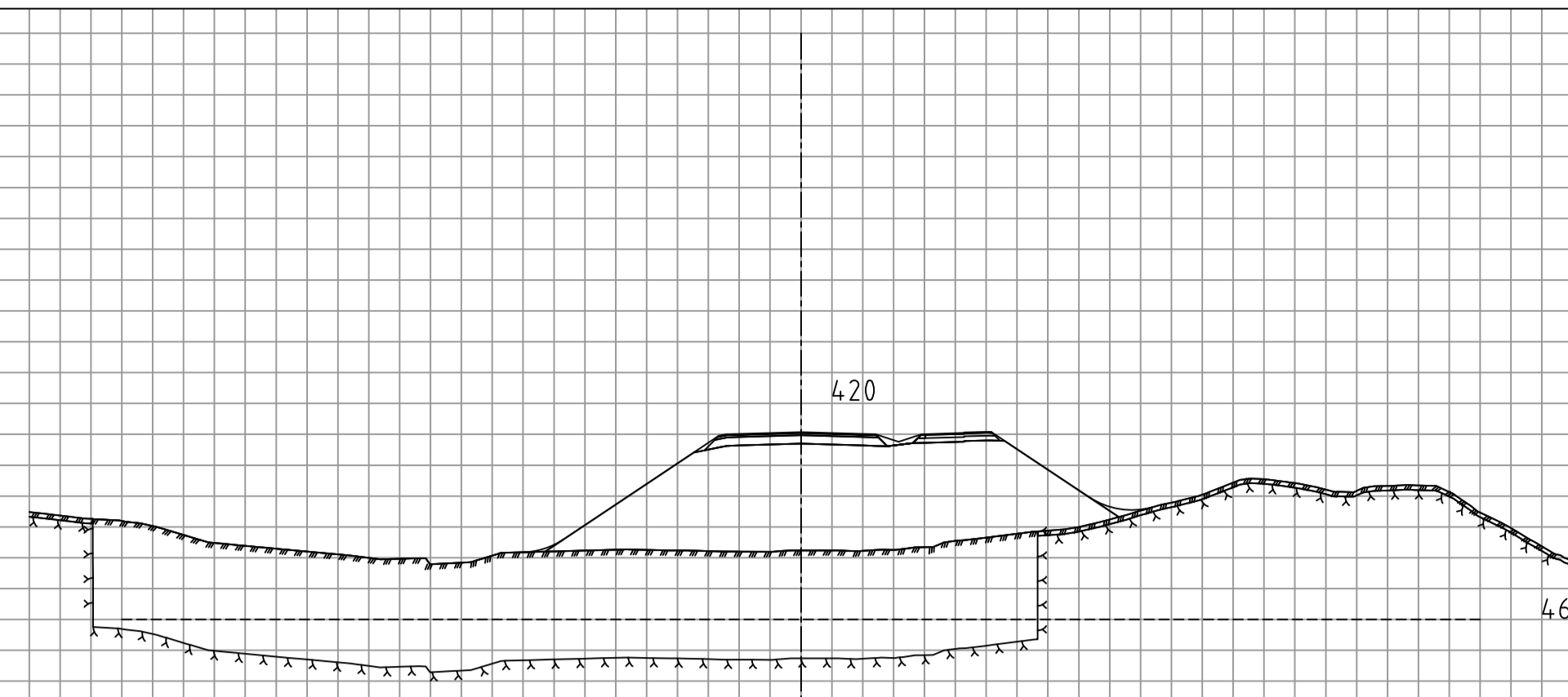

konkurransegrunnlag

Rev.	Dato	Sign.	Revisjonen gjelder		
Oppdragsgiver			Høgskulen på Vestlandet		
Prosjekt			Tegn.	Kontr.	Godkj.
fv.5161 Åsen-Helleskaret			M.H.□		B.A.N
Tverrprofiler profil 400-470			Dato:	19.05.21	
			Målestokk:	Format:	
			1:400	A1	
			Prosjektnr.		
			Tegninger:	Rev.	
			U006		

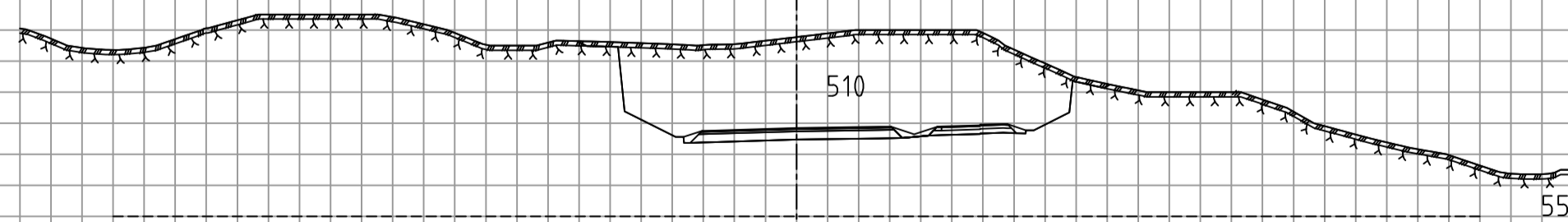
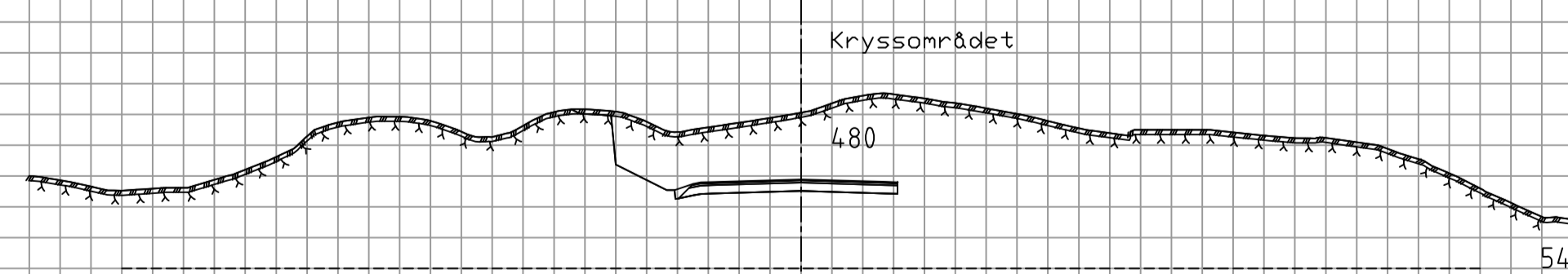
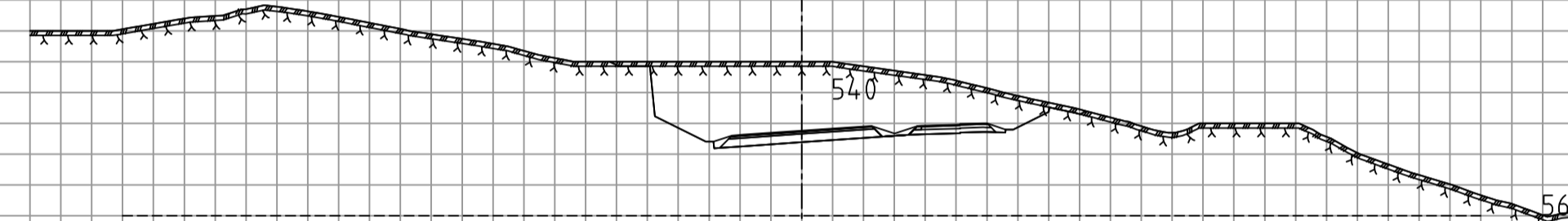
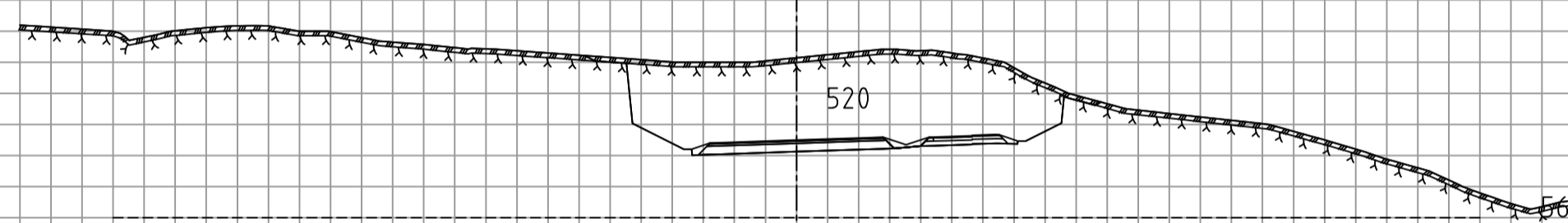
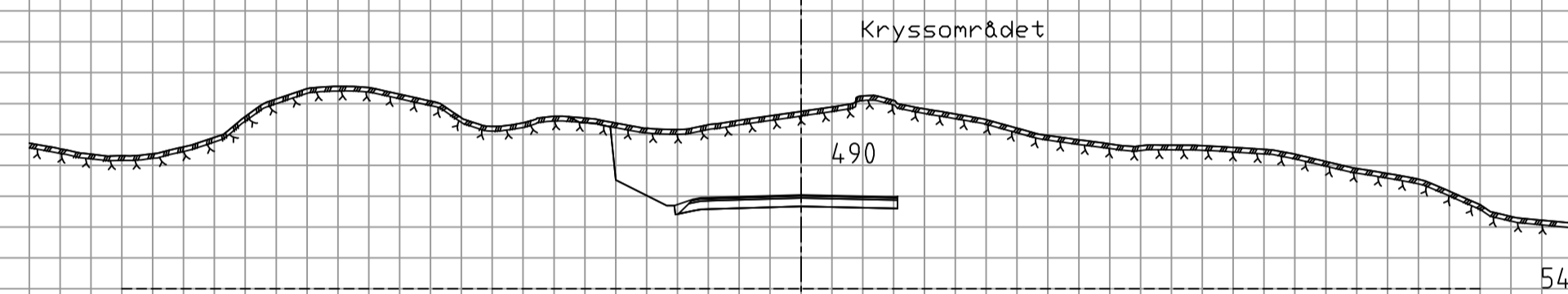
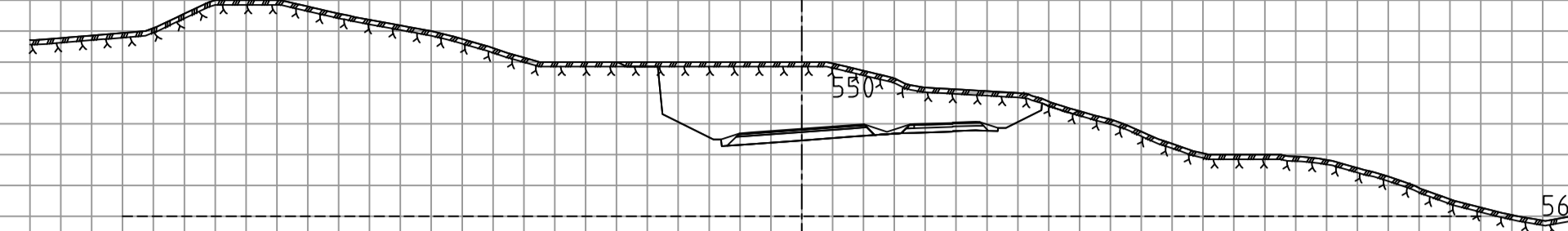
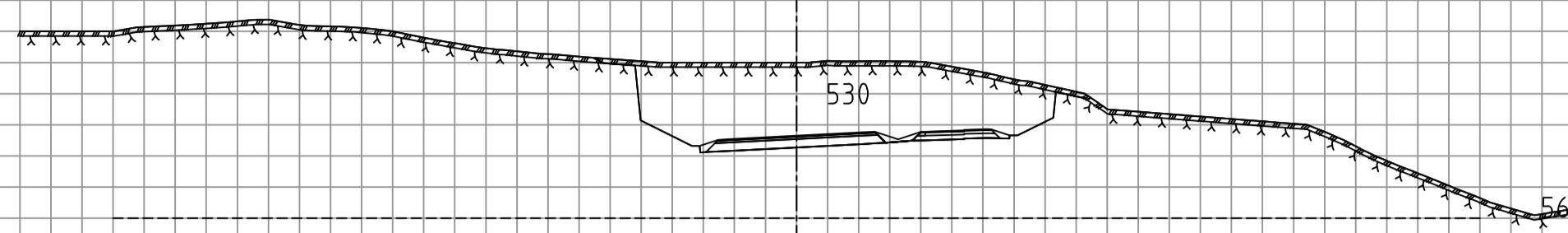
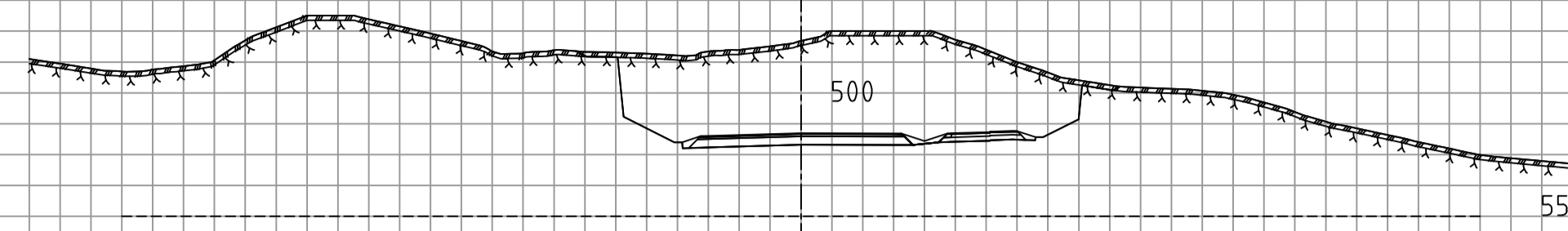

konkurransegrunnlag

Rev.	Dato	Sign.	Revisjonen gjelder		
Oppdragsgiver			Høgskulen på Vestlandet		
Prosjekt			Tegn.	Kontr.	Godkj.
fv.5161 Åsen-Helleskaret			M.H.□		B.A.N
Tverrprofiler profil 480-550			Dato: 19.05.21		
			Målestokk:	Format:	
			1:400	A1	
			Prosjekt nr.		
			Tegning nr.		
			U007		
			Rev.		



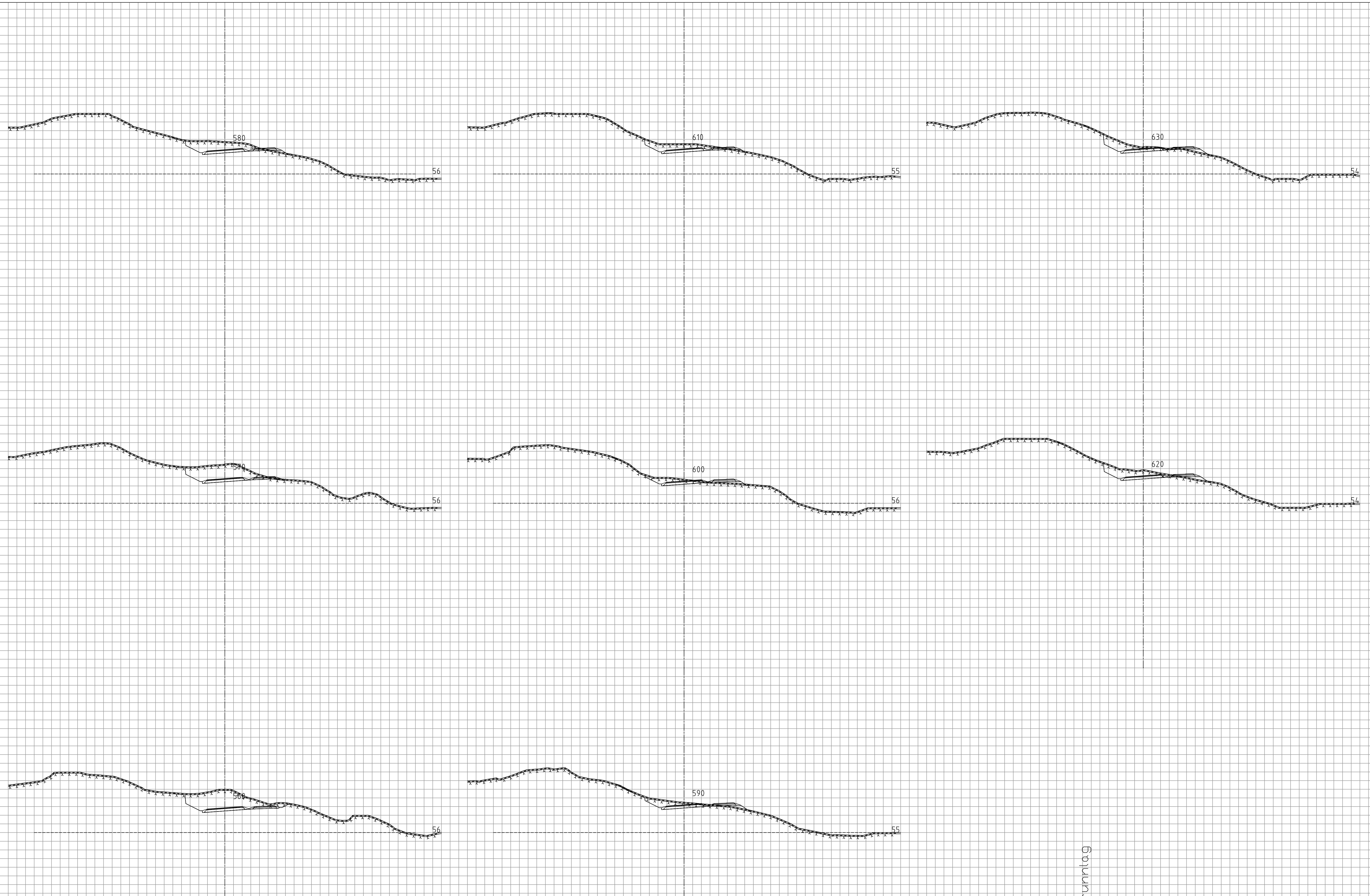

PRODUCED BY AN AUTODESK STUDENT VERSION

PRODUCED BY AN AUTODESK STUDENT VERSION

konkurransegrunnlag

Rev.	Dato	Sign.	Revisjonen gjelder		
Oppdragsgiver			Høgskulen på Vestlandet		
Prosjekt			Tegn.	Kontr.	Godkj.
fv.5161 Åsen-Helleskaret			M.H.□		B.A.N
Tverrprofiler profil 560-630			Dato: 19.05.21		
			Målestokk:	Format:	
			1:400	A1	
			Prosjektnr.		
			Tegningnr.		
			U008		
			Rev.		

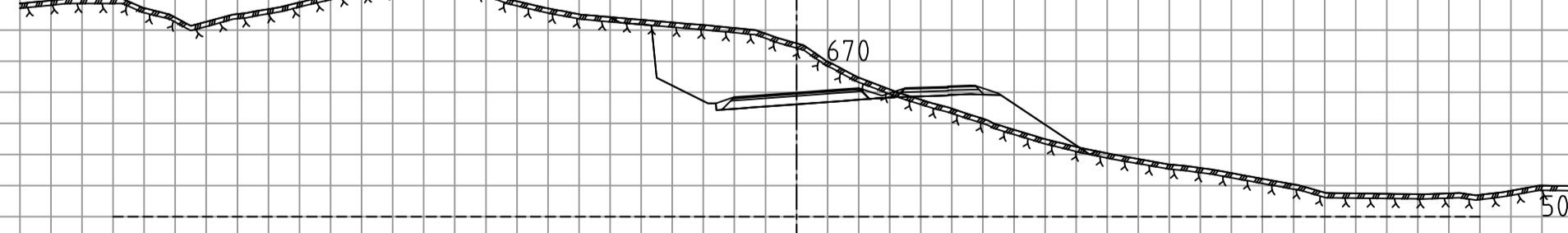
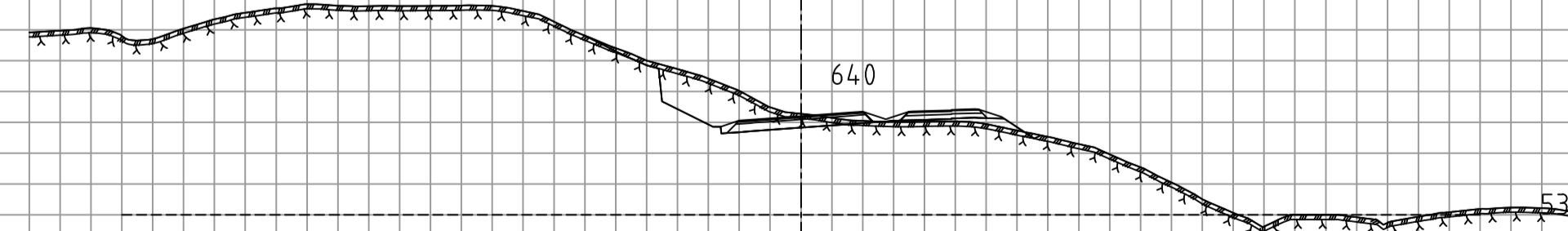
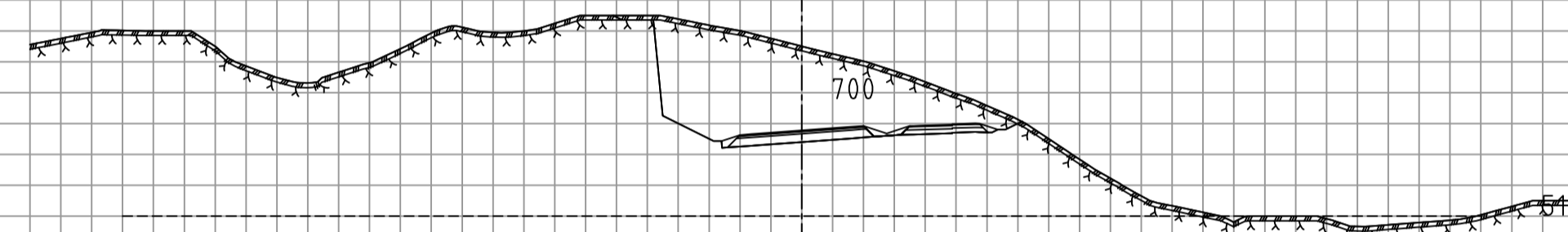
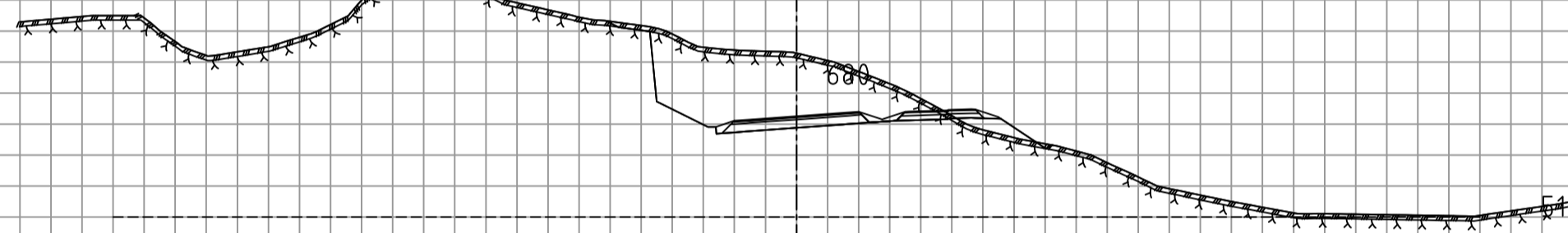
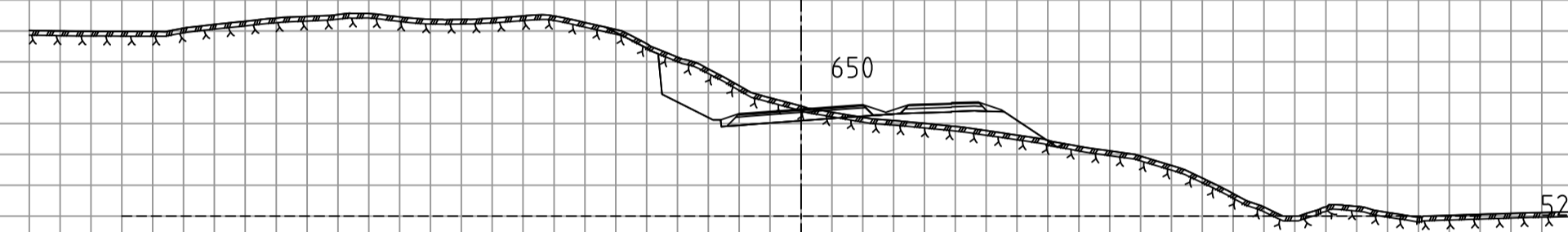
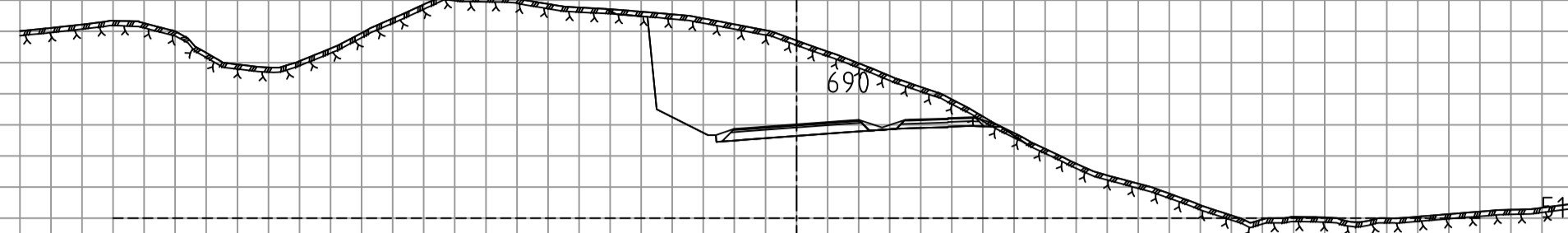

konkurransegrunnlag

Rev.	Dato	Sign.	Revisjonen gjelder		
Oppdragsgiver			Høgskulen på Vestlandet		
Prosjekt			Tegn.	Kontr.	Godkj.
fv.5161 Åsen-Helleskaret			M.H.□		B.A.N
Tverrprofiler profil 640-710			Dato: 19.05.21		
			Målestokk:	Format:	
			1:400	A1	
			Prosjektnr.		
			Tegningsnr.		
			U009		
			Rev.		

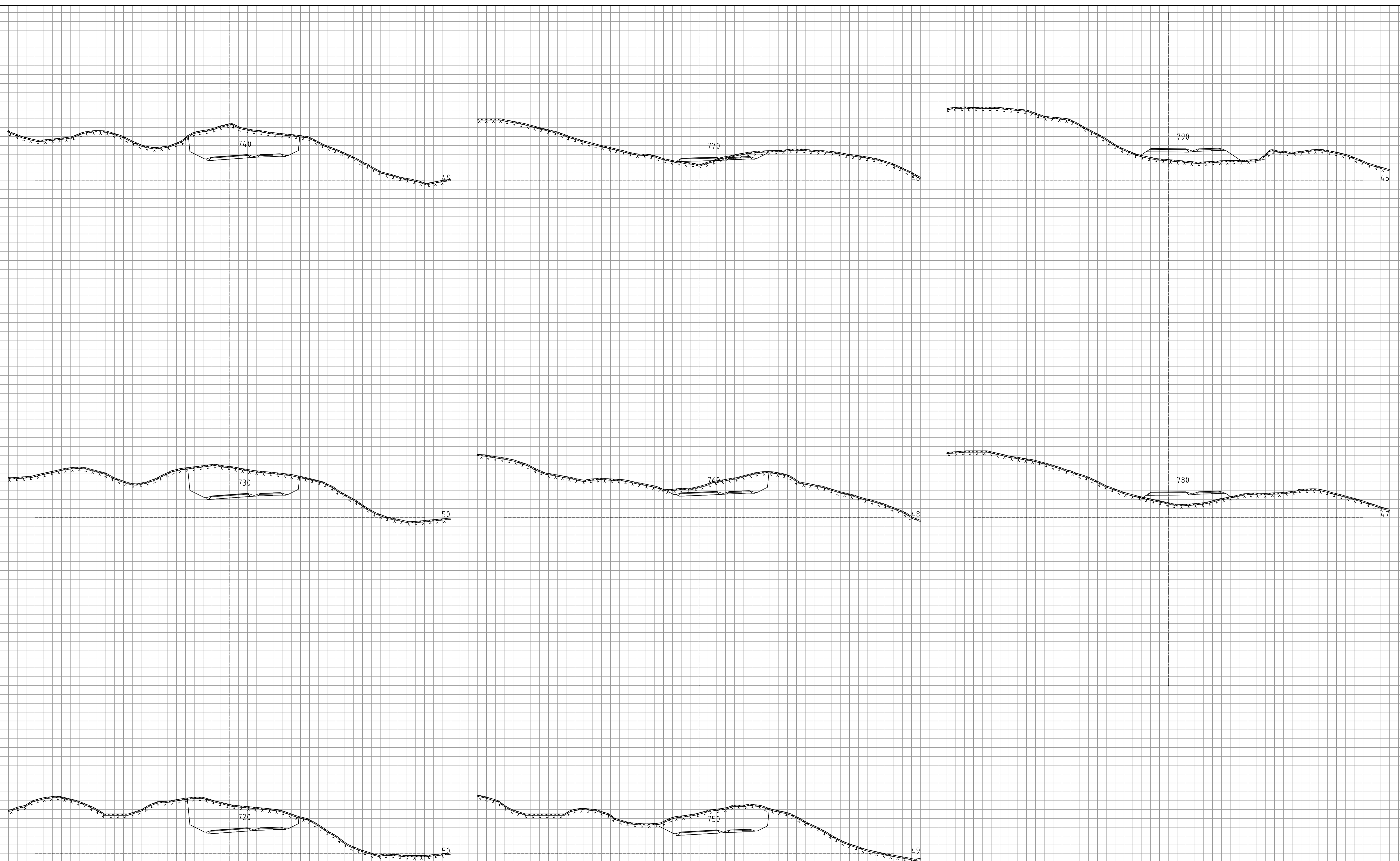

PRODUCED BY AN AUTODESK STUDENT VERSION

PRODUCED BY AN AUTODESK STUDENT VERSION

konkurransegrunnlag

Rev.	Dato	Sign.	Revisjonen gjelder		
Oppdragsgiver			Høgskulen på Vestlandet		
Prosjekt			Tegn.	Kontr.	Godkj.
fv.5161 Åsen-Helleskaret			M.H.□		B.A.N
Tverrprofiler profil 720-790			Dato: 19.05.21		
			Målestokk:	Format:	
			1:400	A1	
			Prosjektnr.		
			Tegningsnr.		
			U010		
			Rev.		



PRODUCED BY AN AUTODESK STUDENT VERSION

PRODUCED BY AN AUTODESK STUDENT VERSION

konkurransegrunnlag

Rev.	Dato	Sign.	Revisjonen gjelder		
Oppdragsgiver			Høgskulen på Vestlandet		
Prosjekt			Tegn.	Kontr.	Godkj.
fv.5161 Åsen-Helleskaret			M.H.□		B.A.N
Tverrprofiler profil 800-870			Dato:	19.05.21	
			Målestokk:	1:400	
			Prosjektnr.	Format: A1	
			Tegningsnr.	U011	
			Rev.		

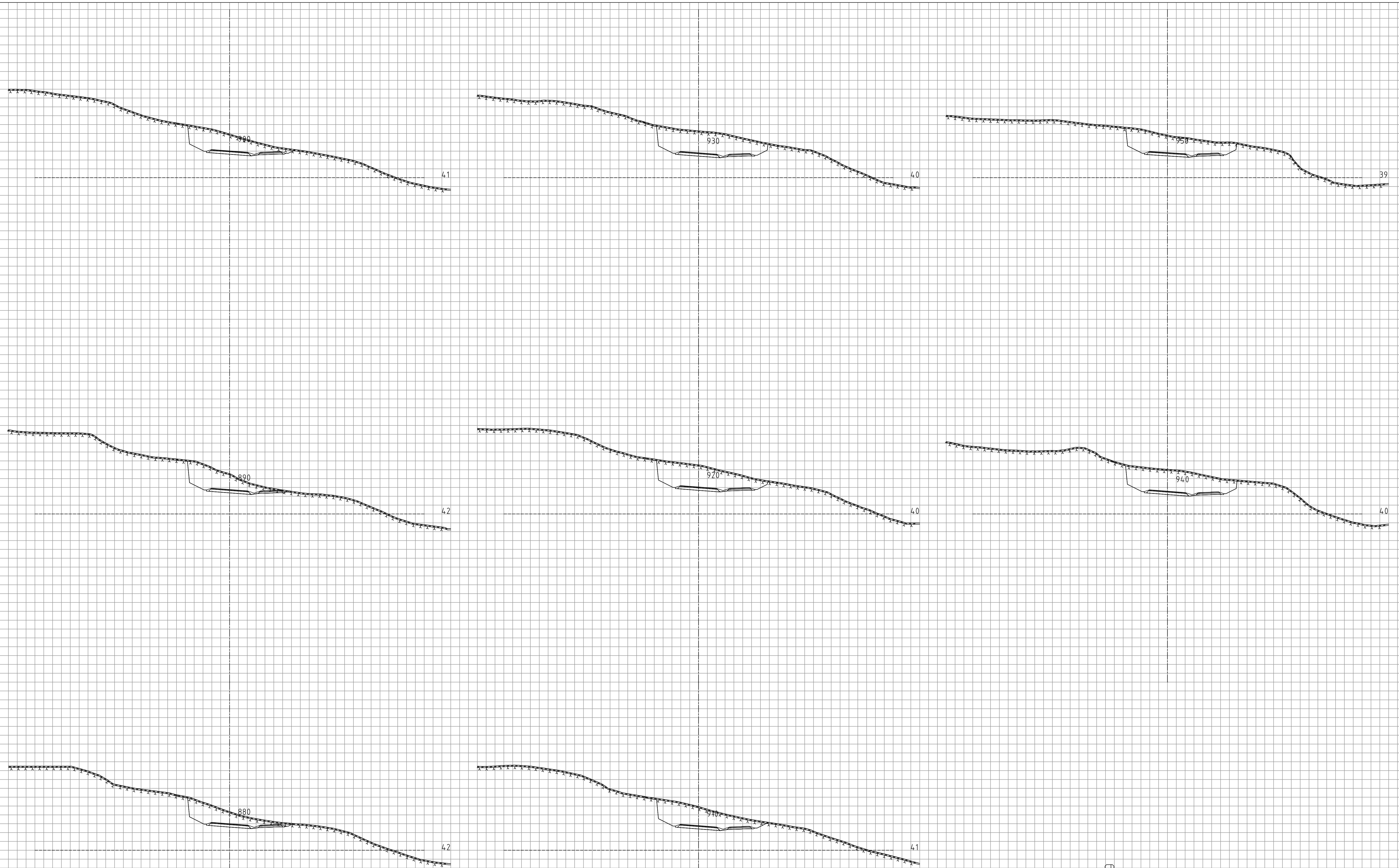

konkurransegrunnlag

Rev.	Dato	Sign.	Revisjonen gjelder		
Oppdragsgiver			Høgskulen på Vestlandet		
Prosjekt			Tegn.	Kontr.	Godkj.
fv.5161 Åsen-Helleskaret			M.H.Ø		B.A.N
Tverrprofiler profil 880-950			Dato: 19.05.21		
			Målestokk:	Format:	
			1:400	A1	
			Prosjektnr.		
			Tegningsnr.	U012	Rev.

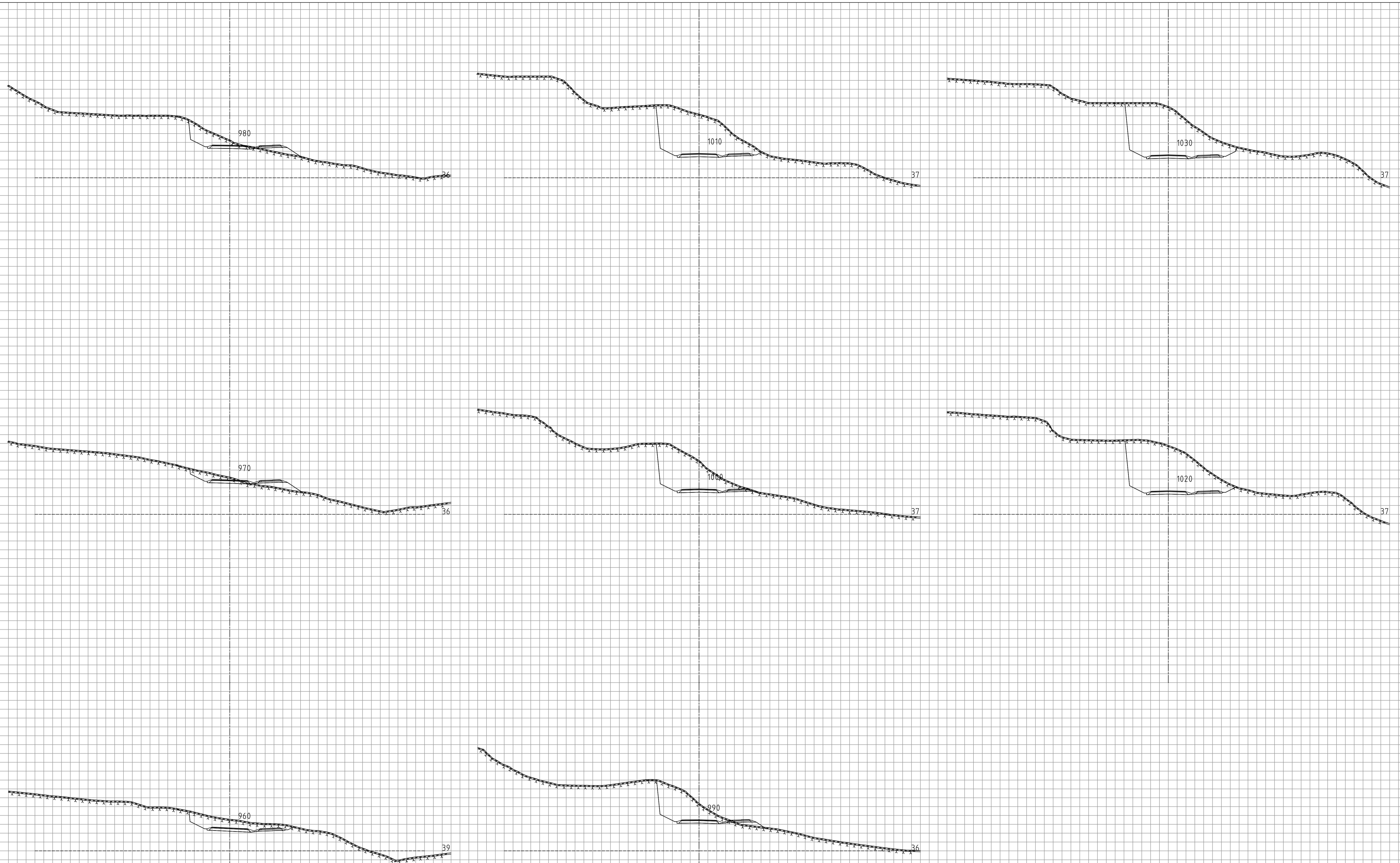

konkurransegrunnlag

Rev.	Dato	Sign.	Revisjonen gjelder		
Oppdragsgiver			Høgskulen på Vestlandet		
Prosjekt			Tegn.	Kontr.	Godkj.
fv.5161 Åsen-Helleskaret			M.H.□		B.A.N
Tverrprofiler profil 960-1030			Dato: 19.05.21		
			Målestokk:	Format:	
			1:400	A1	
			Prosjektnr.		
			Tegningsnr.	Rev.	
			U013		

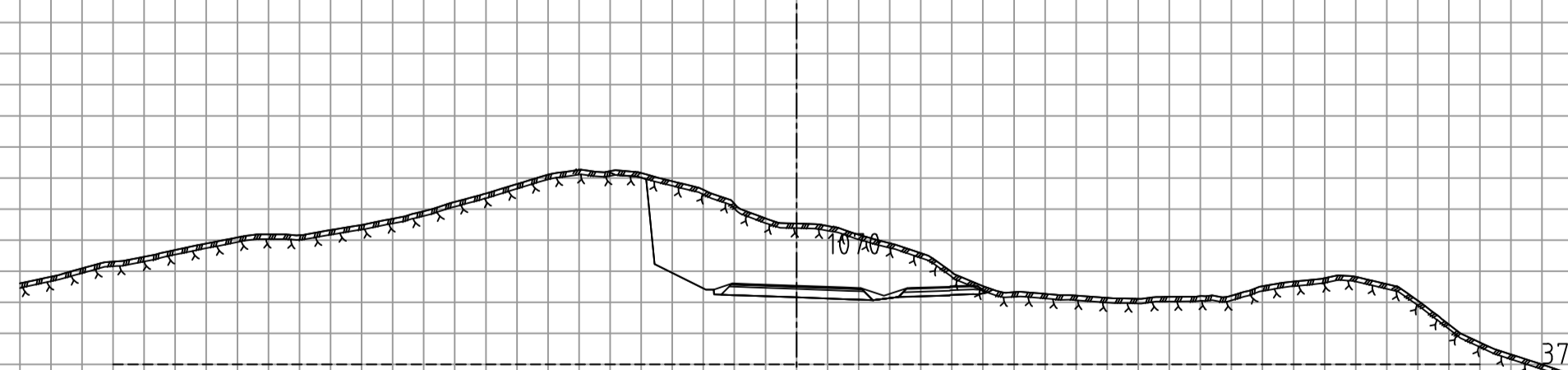
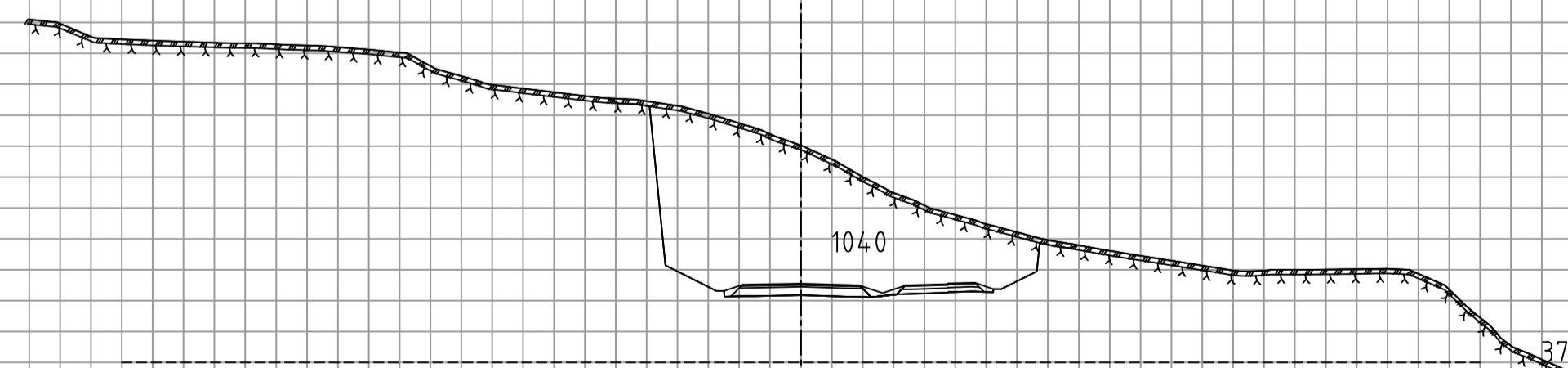
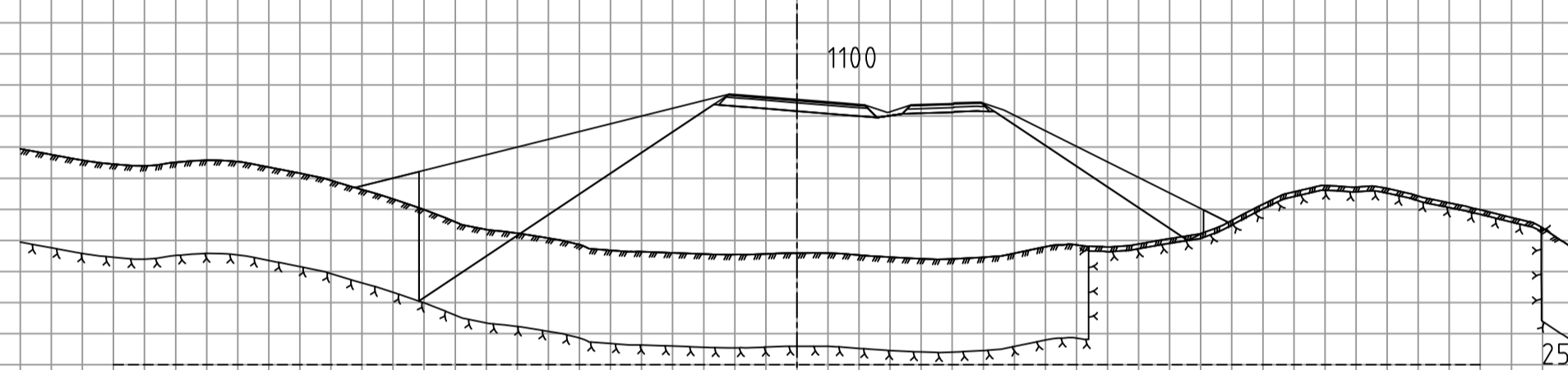
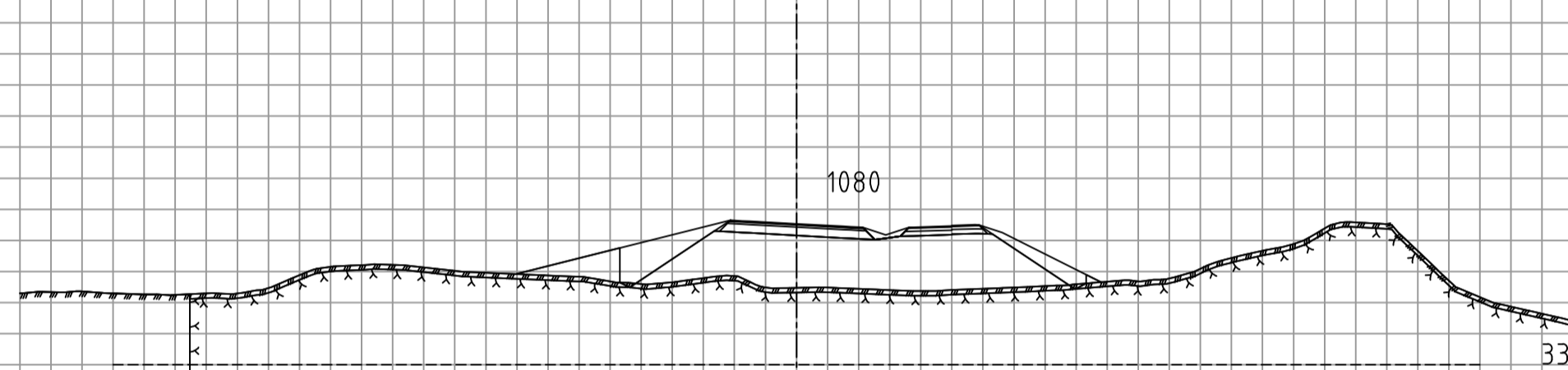
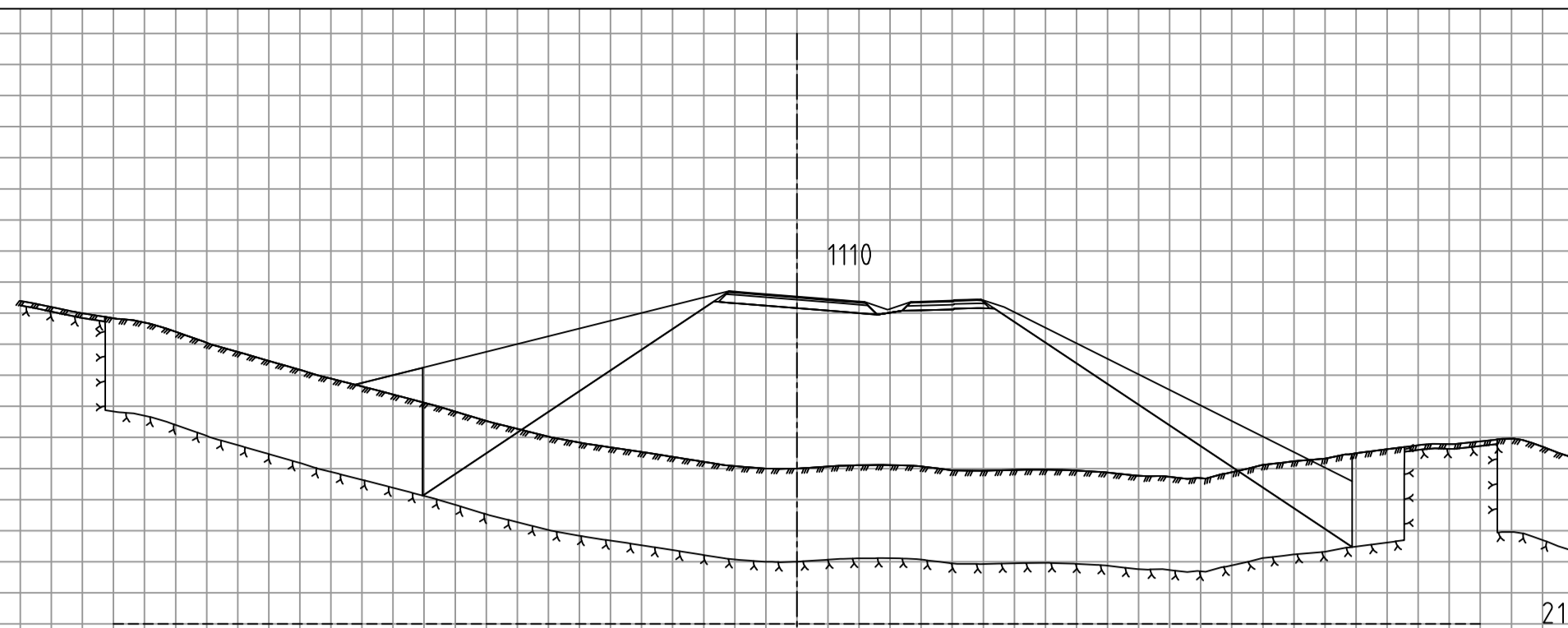
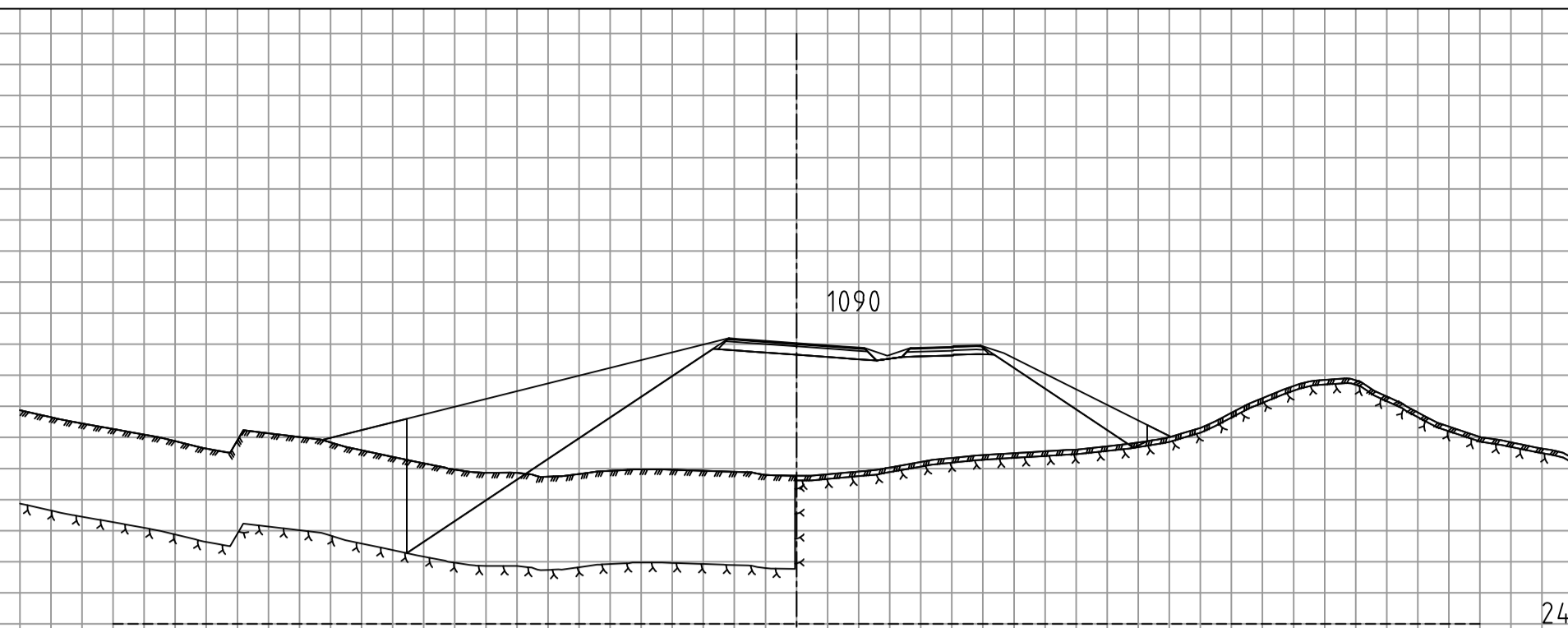
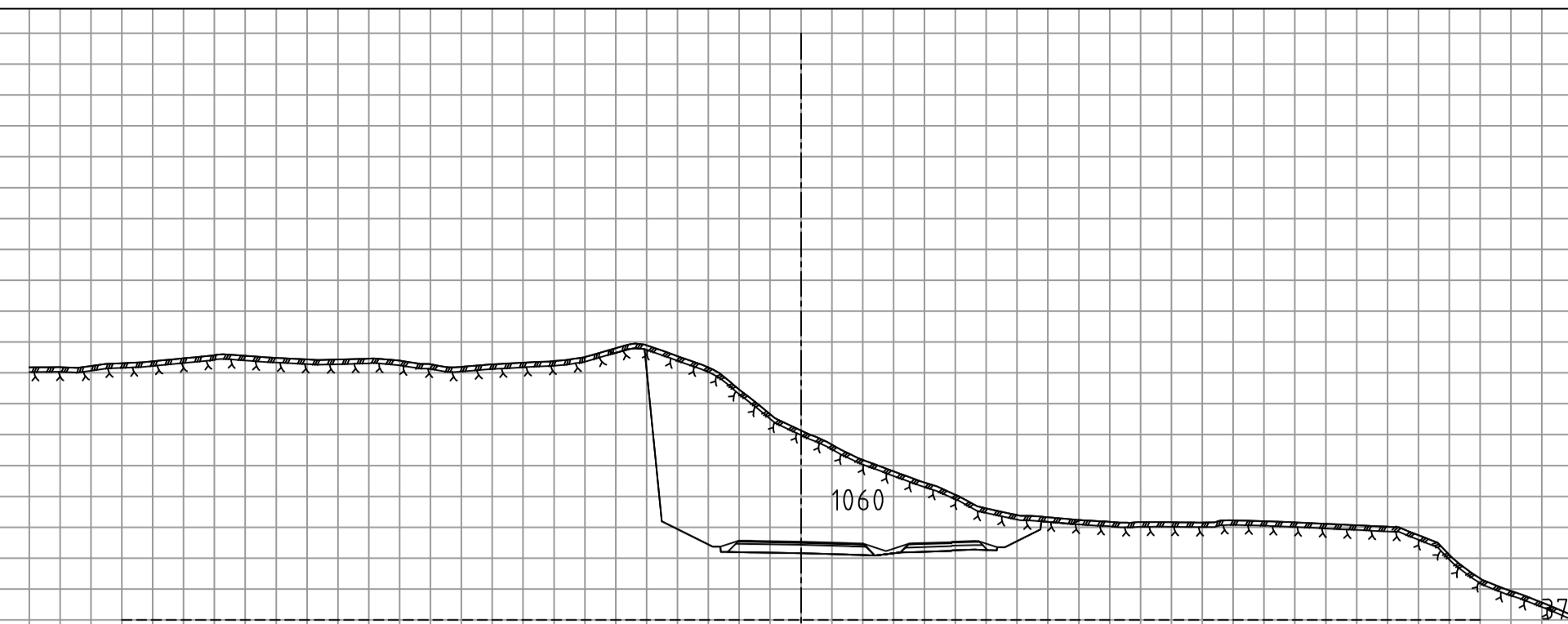

konkurransegrunnlag

Rev.	Dato	Sign.	Revisjonen gjelder		
Oppdragsgiver			Høgskulen på Vestlandet		
Prosjekt			Tegn.	Kontr.	Godkj.
fv.5161 Åsen-Helleskaret			M.H.□		B.A.N
Tverrprofiler profil 1040-1110			Dato: 19.05.21		
			Målestokk:	Format:	
			1:400	A1	
			Prosjekt nr.		
			Tegningsnr.		
			U014		
			Rev.		

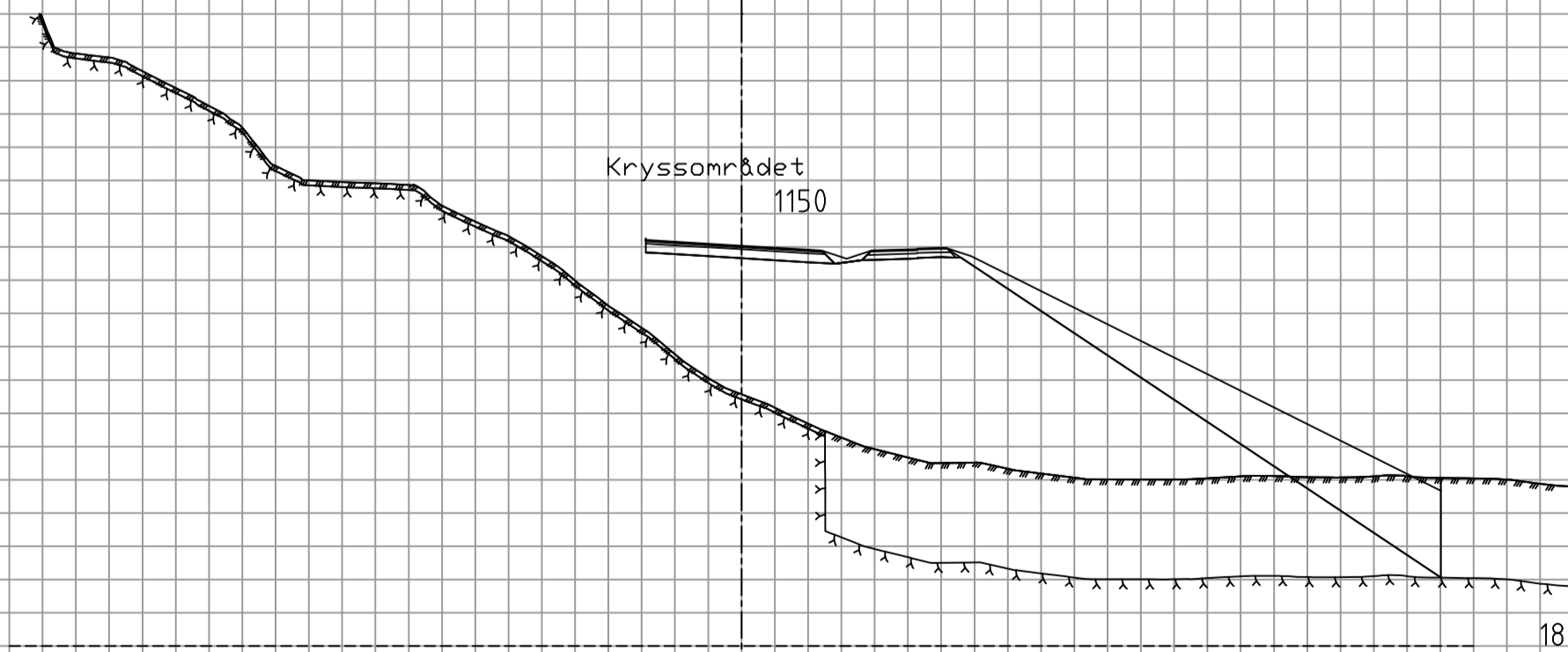
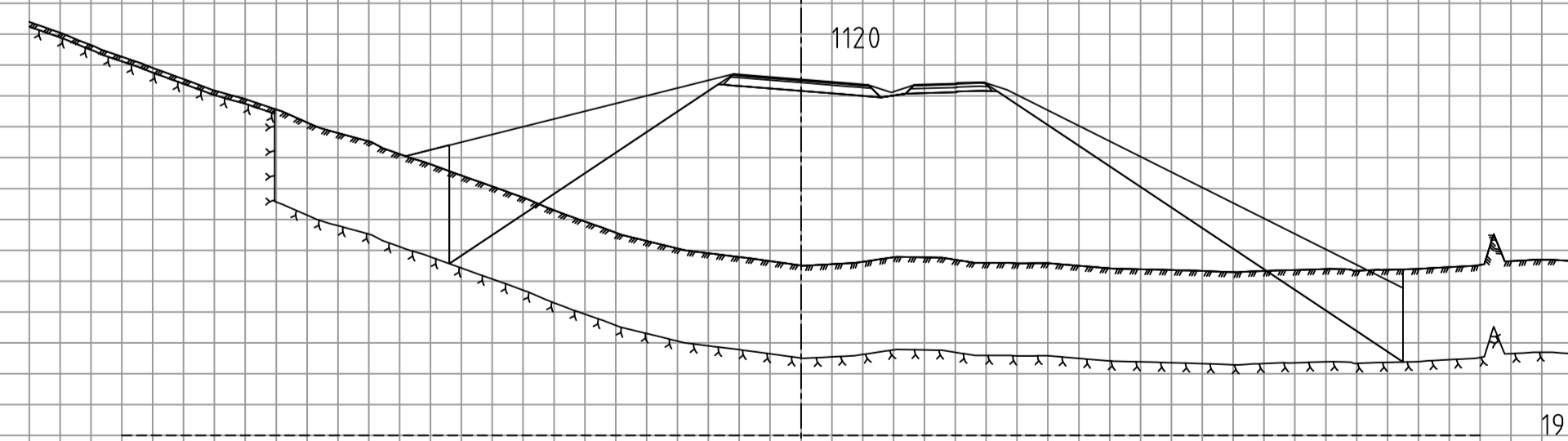
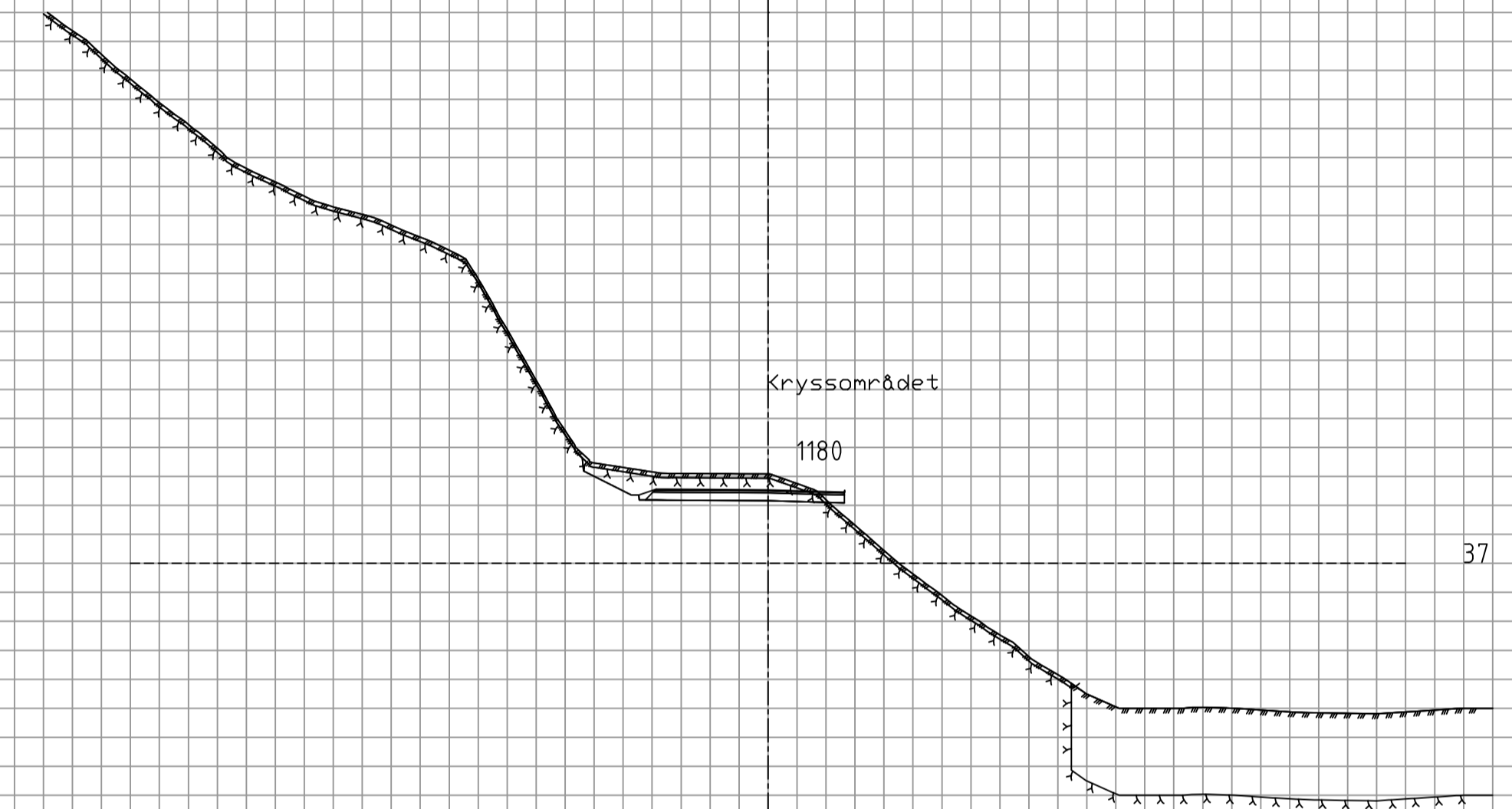
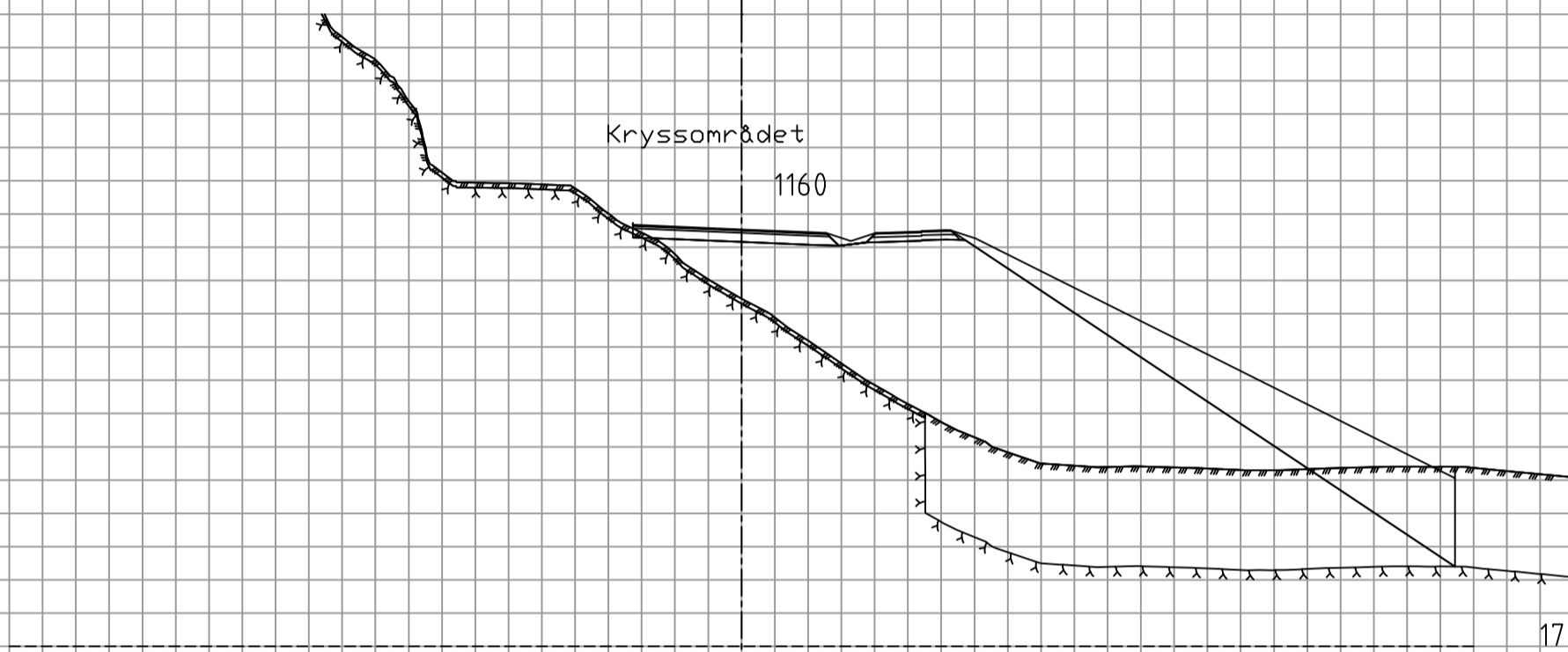
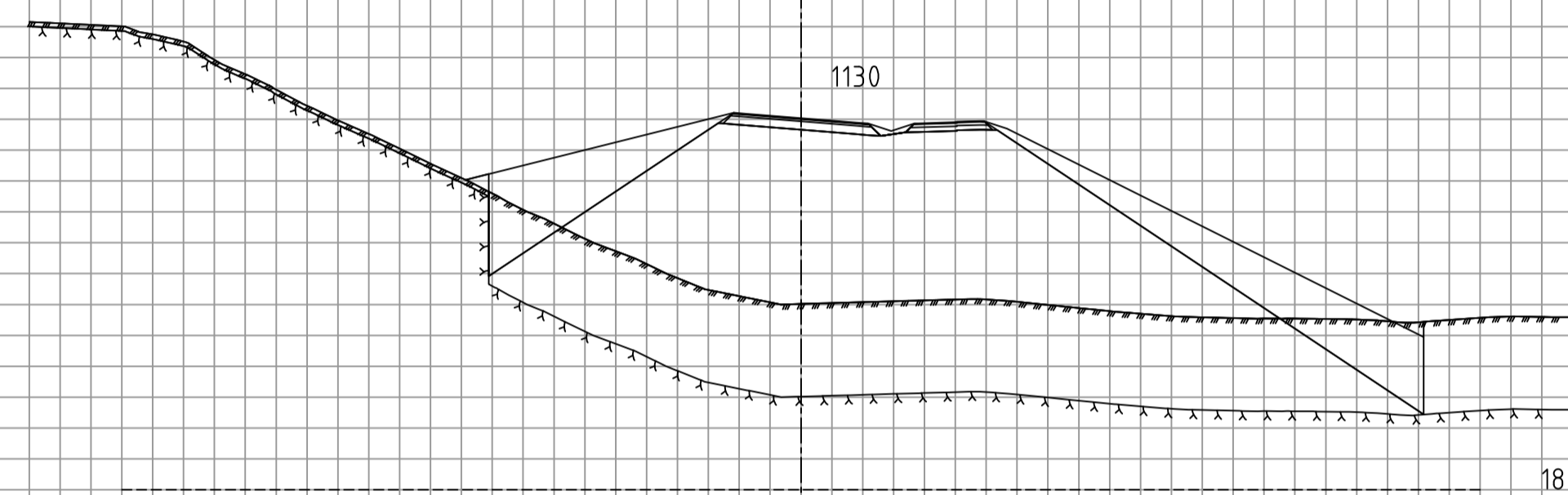
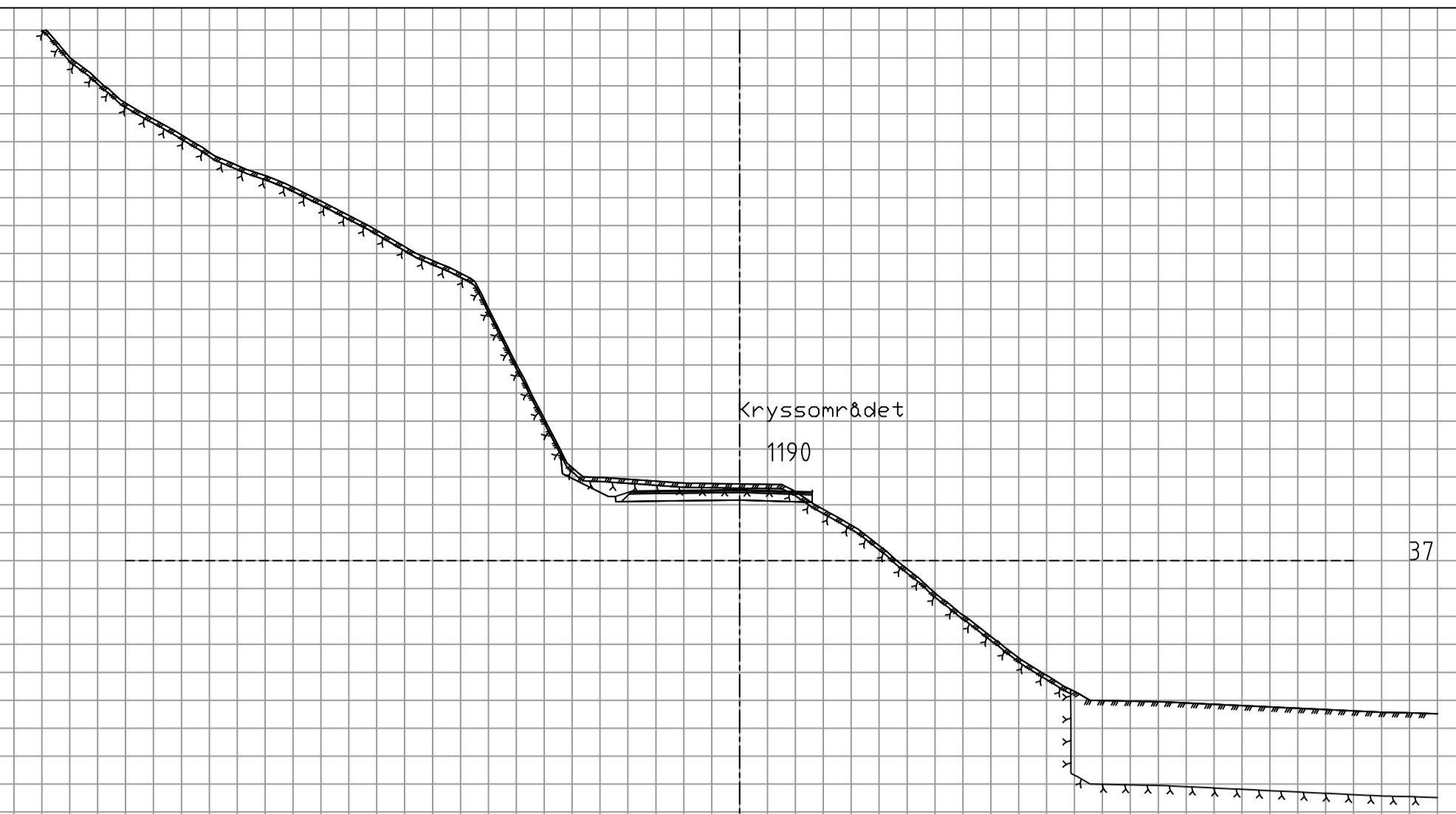
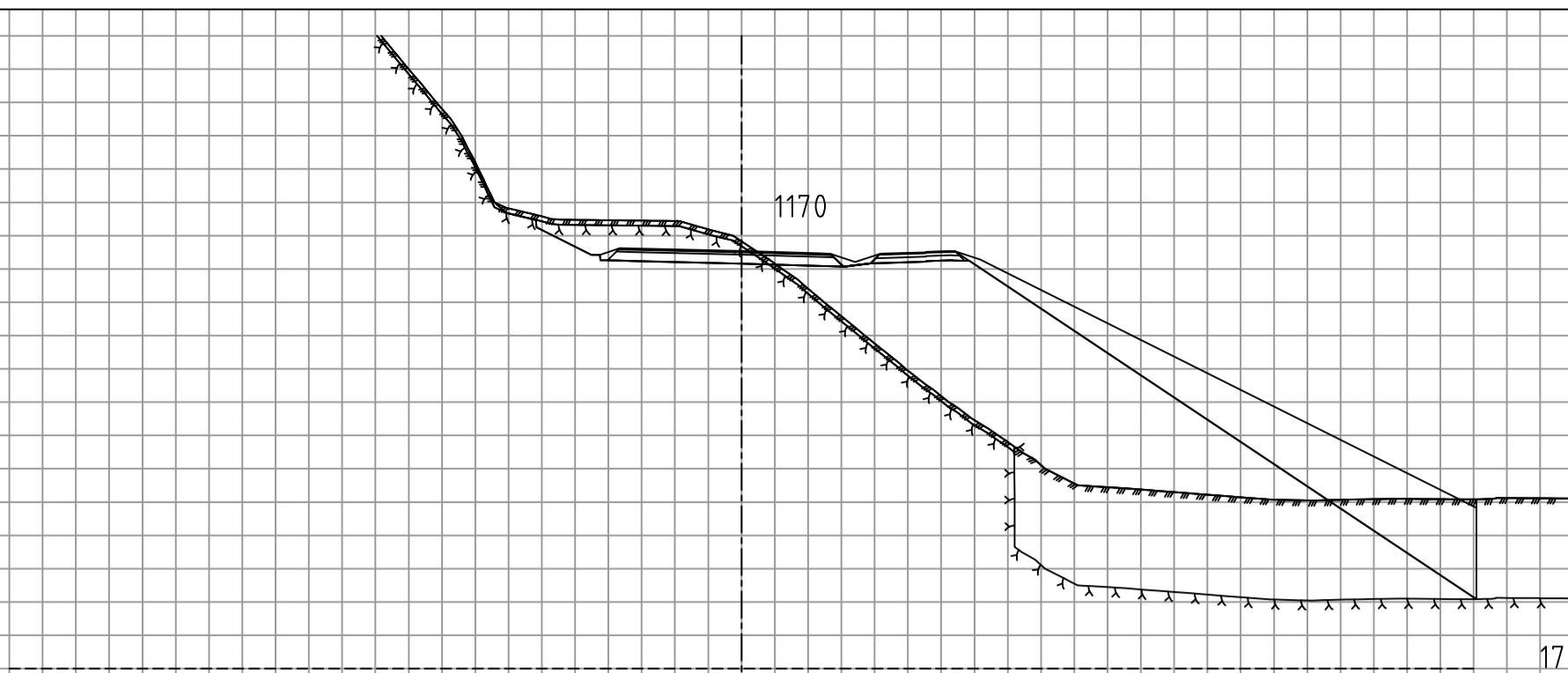
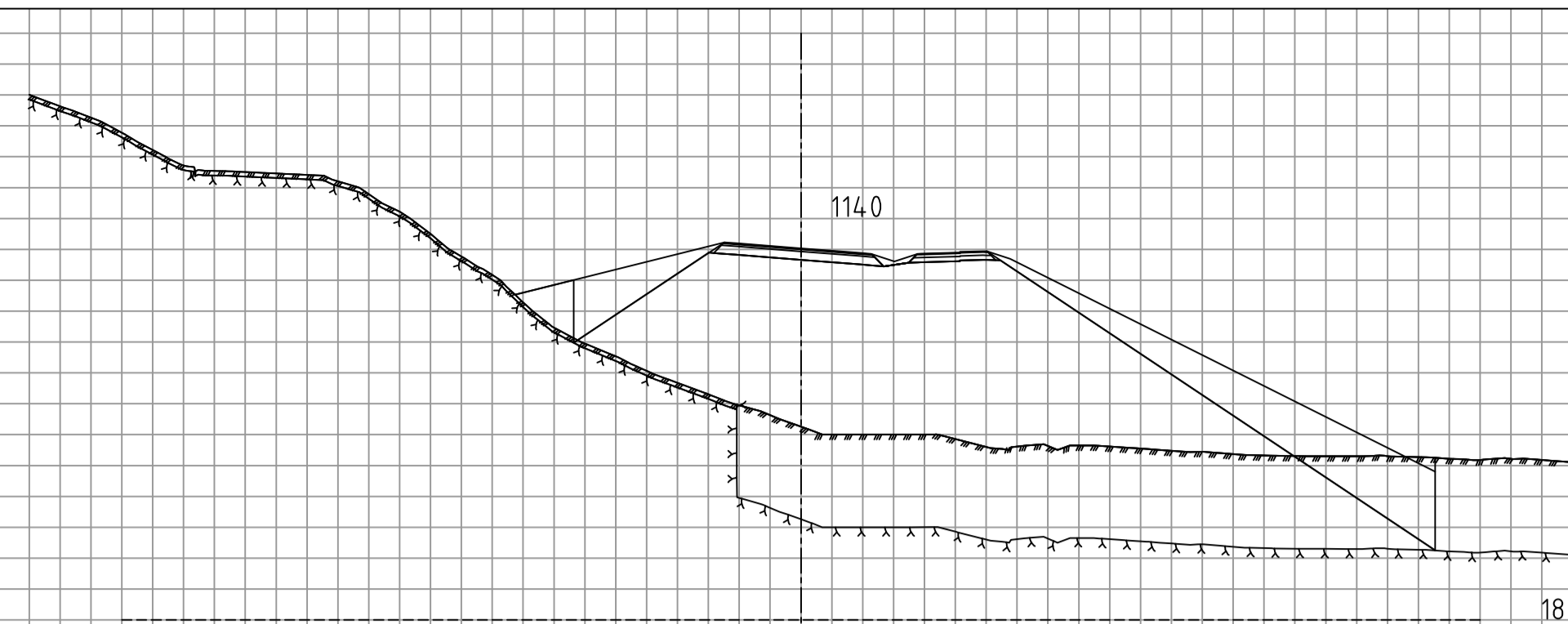

konkurransegrunnlag

Rev.	Dato	Sign.	Revisjonen gjelder		
Oppdragsgiver			Høgskulen på Vestlandet		
Prosjekt			Tegn.	Kontr.	Godkj.
fv.5161 Åsen-Helleskaret			M.H.□		B.A.N
Tverrprofiler profil 1120-1190			Dato: 19.05.21		
			Målestokk:	Format:	
			1:400	A1	
			Prosjektnr.		
			Tegningsnr.		
			U015		
			Rev.		



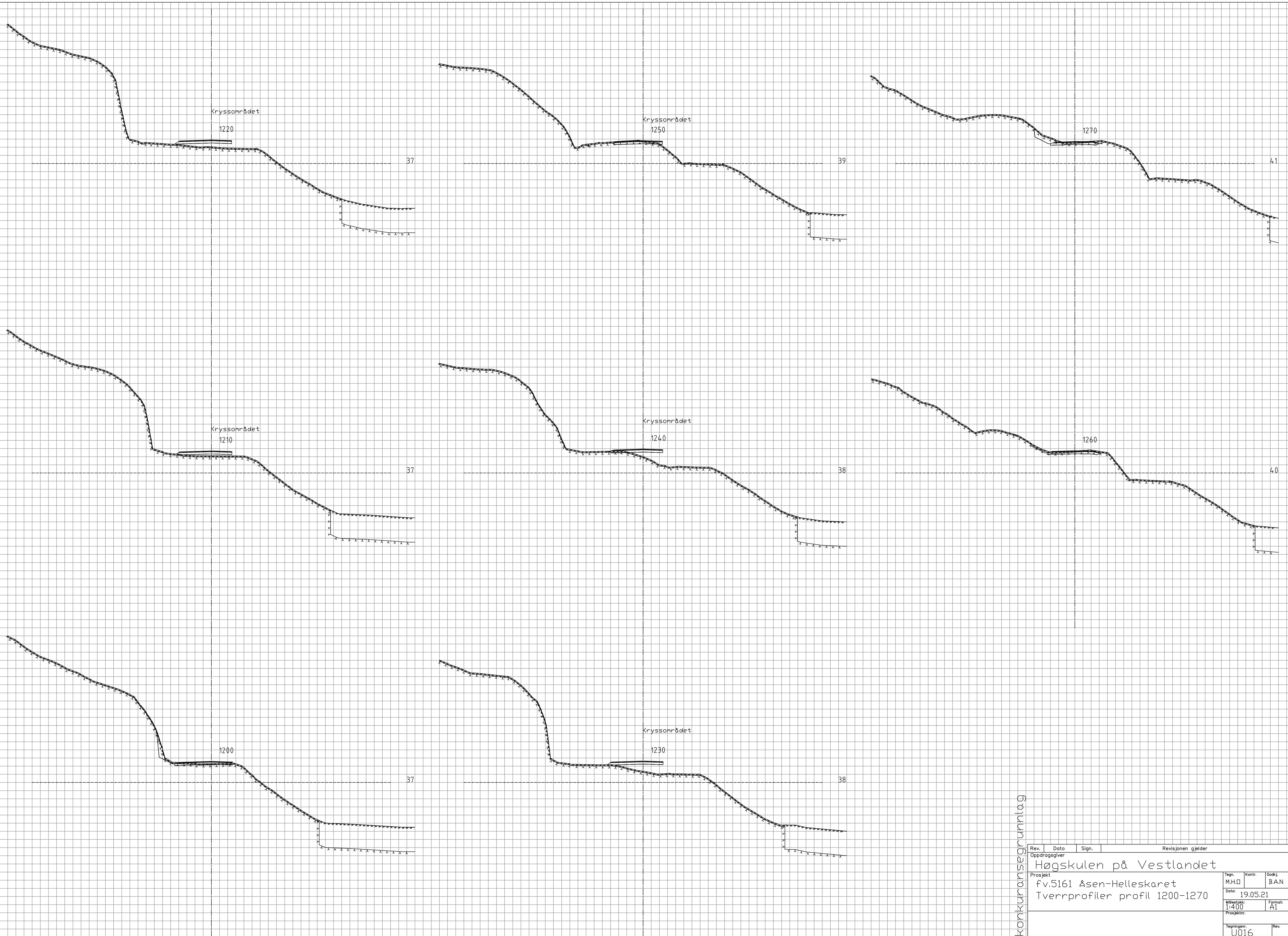

PRODUCED BY AN AUTODESK STUDENT VERSION

PRODUCED BY AN AUTODESK STUDENT VERSION

konkurransegrunnlag

Rev.	Dato	Sign.	Revisjonen gjelder		
Oppdragsgiver			Høgskulen på Vestlandet		
Prosjekt	fv.5161 Åsen-Helleskaret		Tegn.	Kontr.	Godkj.
Tverrprofiler profil 1200-1270			M.H.□	B.A.N	
			Dato:	19.05.21	
			Målestokk:	1:400	
			Prosjekt nr.	Format: A1	
			Tegningsnr.	U016	
			Rev.		

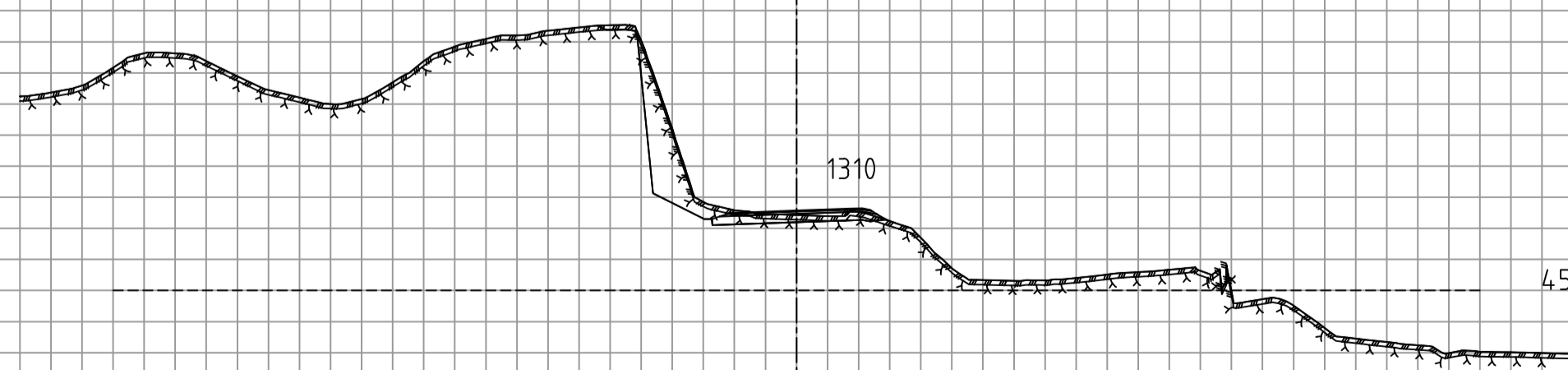
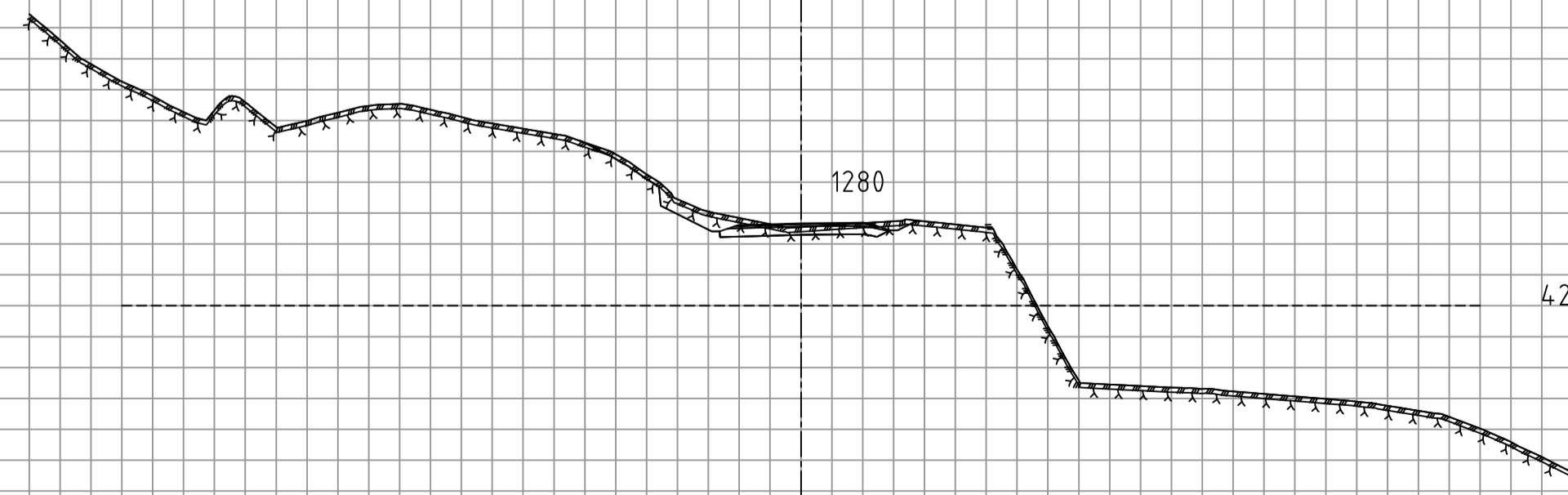
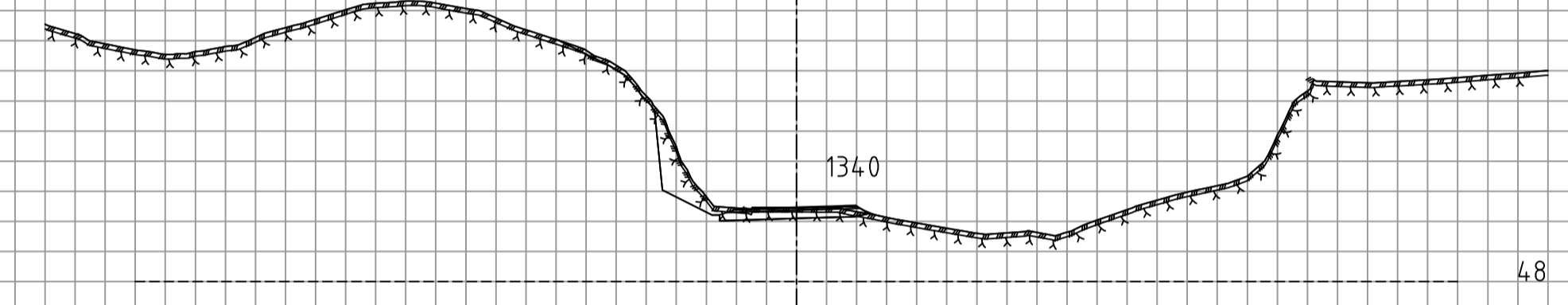
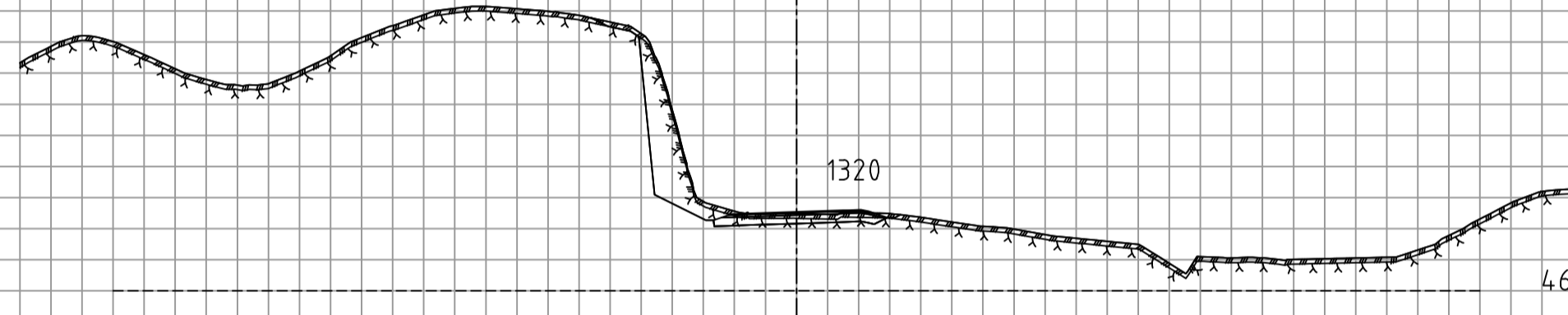
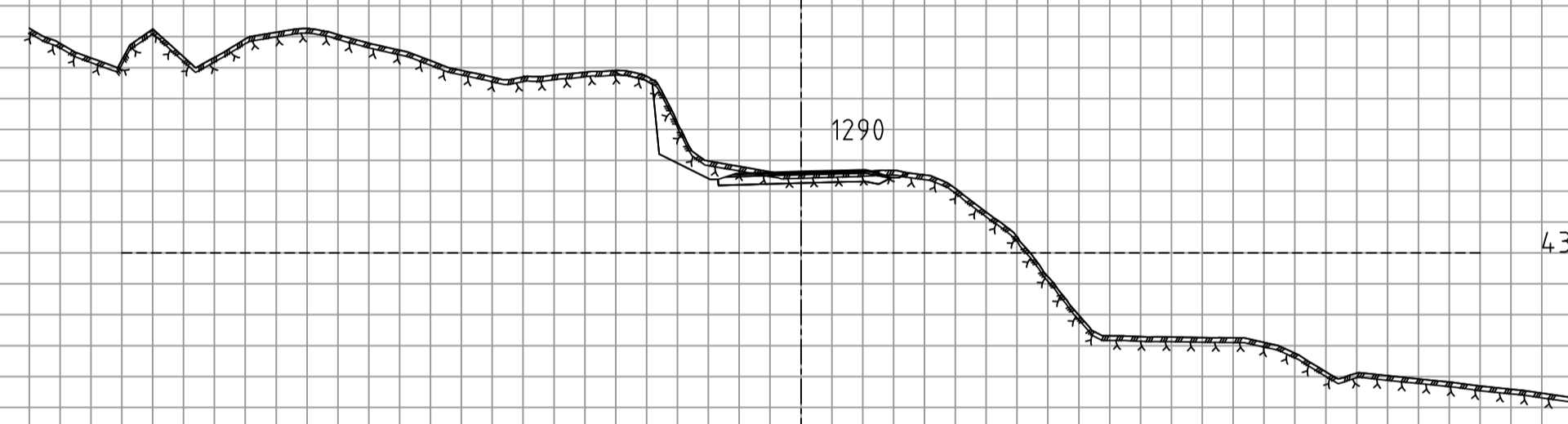
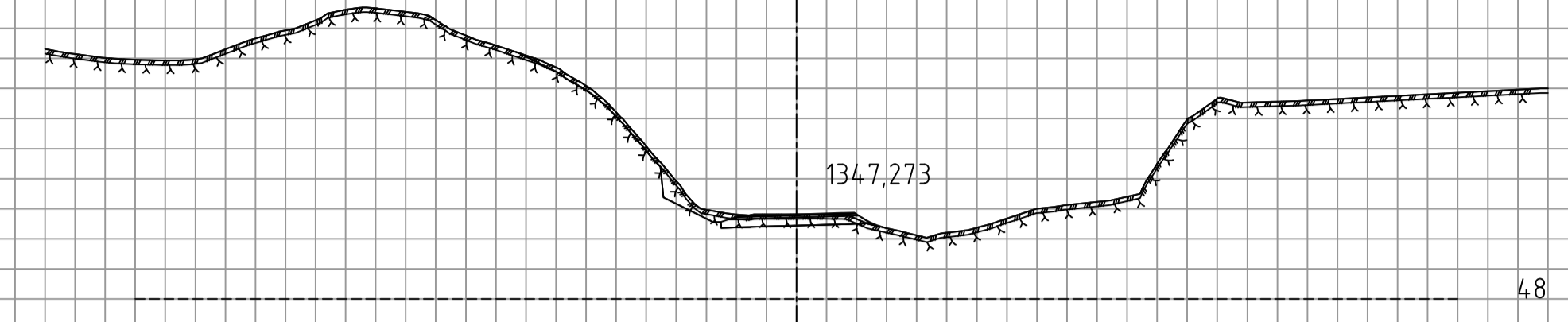
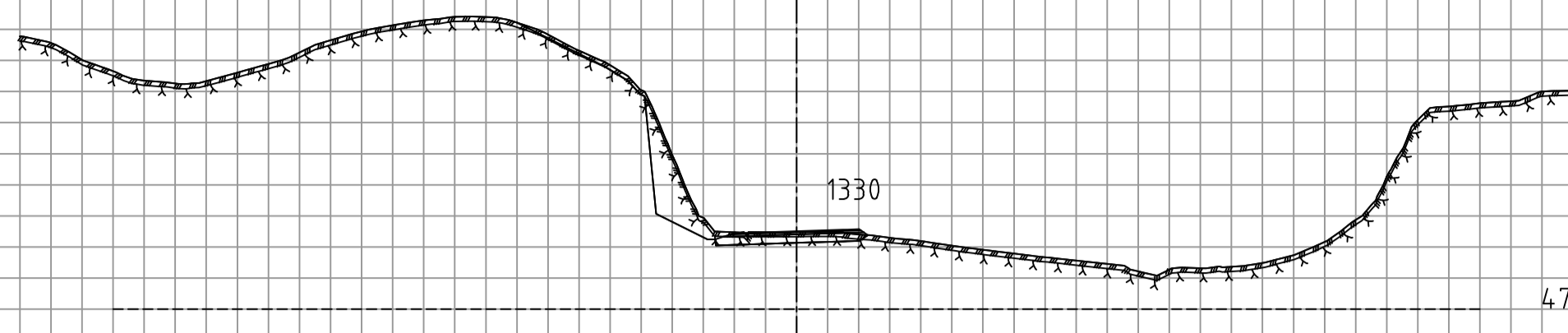
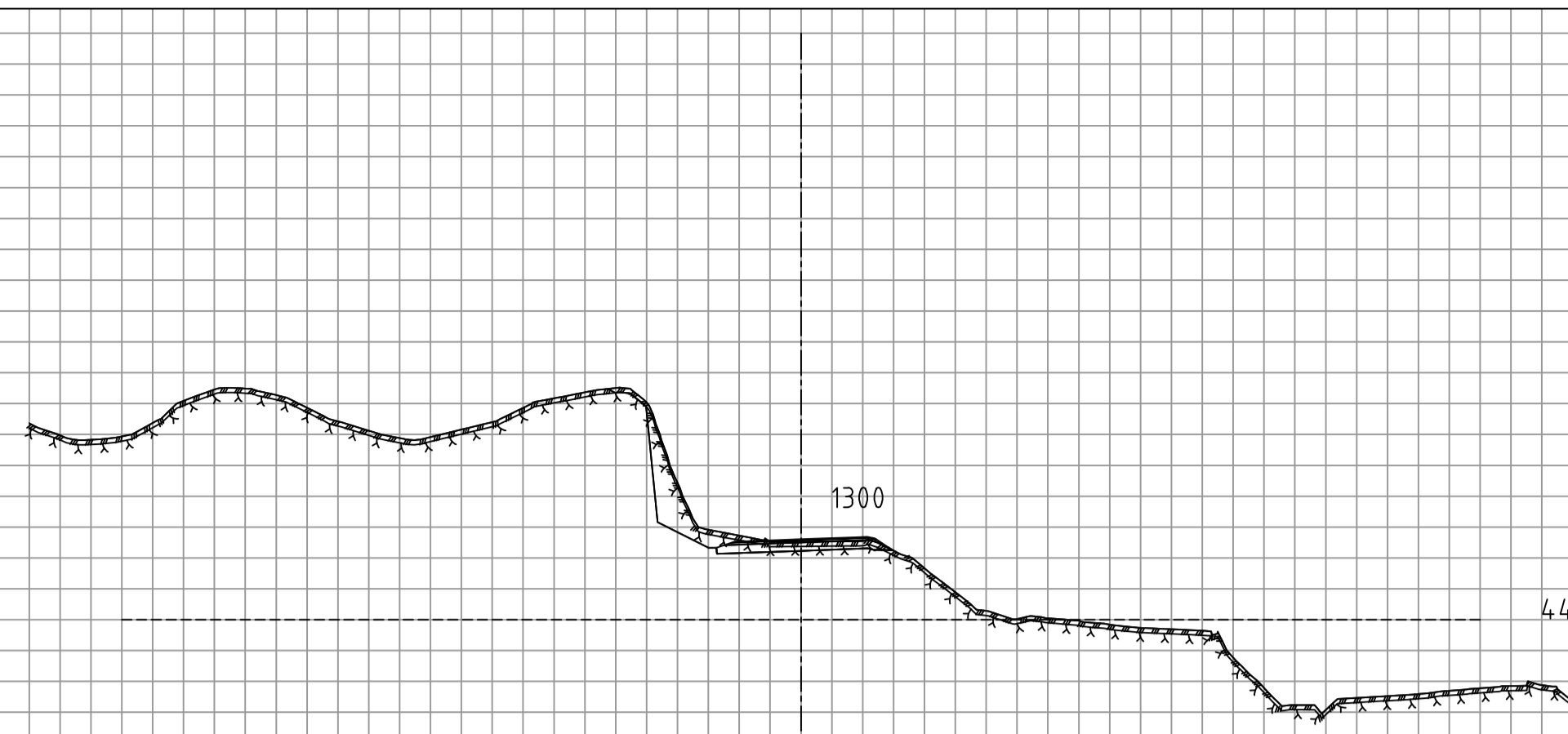

konkurransegrunnlag

Rev.	Dato	Sign.	Revisjonen gjelder		
Oppdragsgiver			Høgskulen på Vestlandet		
Prosjekt			Tegn.	Kontr.	Godkj.
fv.5161 Åsen-Helleskaret			M.H.□		B.A.N
Tverrprofiler profil 1280-1347			Dato: 19.05.21		
			Målestokk: 1:400	Format: A1	
			Prosjektnr.		
			Tegningsnr.	Rev.	
			U017		

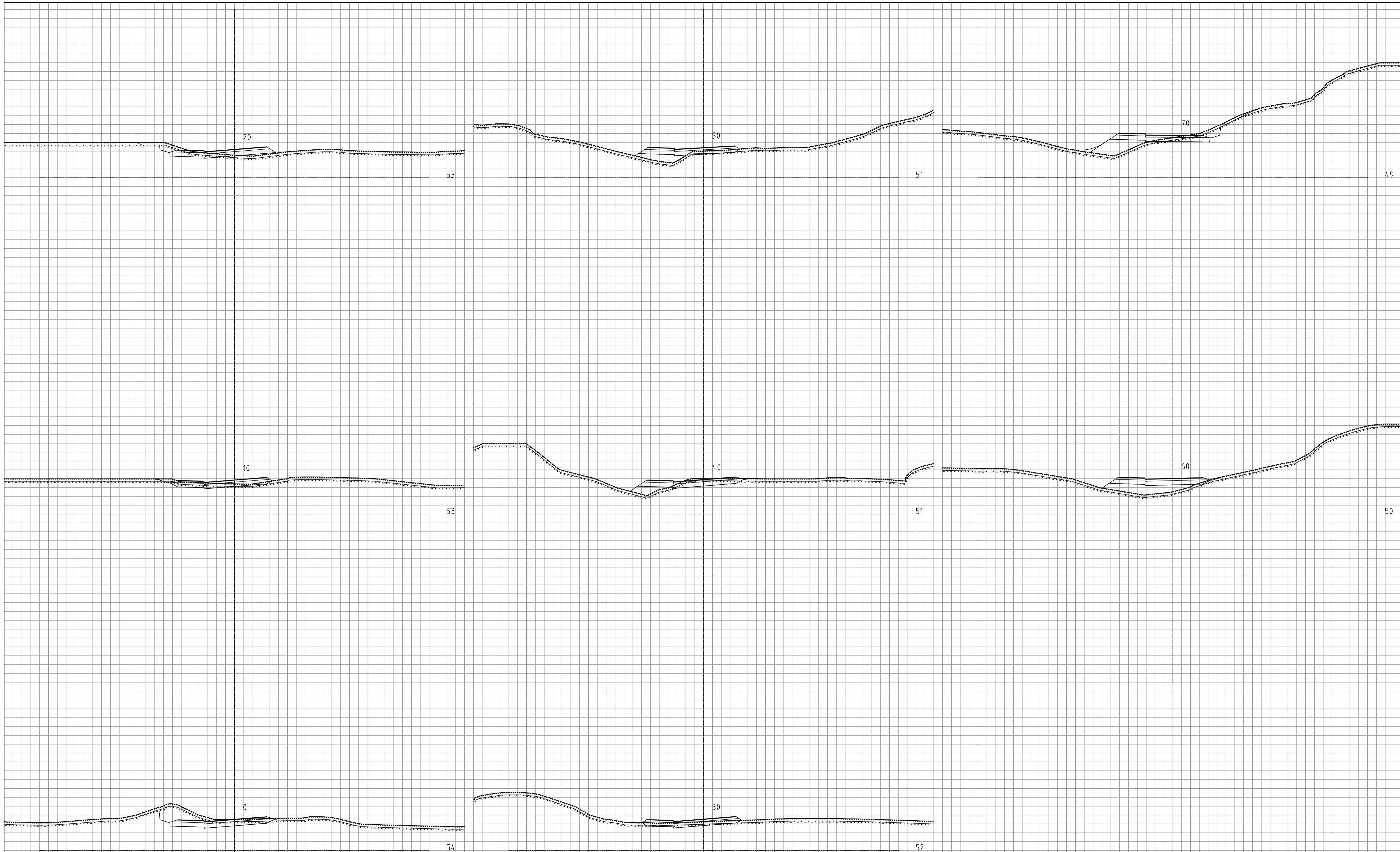

PRODUCED BY AN AUTODESK STUDENT VERSION

PRODUCED BY AN AUTODESK STUDENT VERSION

konkurransegrunnlag

Rev.	Dato	Sign.	Revisjonen gjelder		
Oppdragsgiver			Høgskulen på Vestlandet		
Prosjekt			Tegn.	Kontr.	Godkj.
fv.5161 Åsen-Helleskaret			M.H.□		B.A.N
Tverrprofiler profil 0-70			Dato: 19.05.21		
Tilkomstveg Revsåsen (Veg 20000)			Målestokk:	Format:	
			1:200	A1	
			Prosjektnr.		
			Tegningsnr.	Rev.	
			U101		

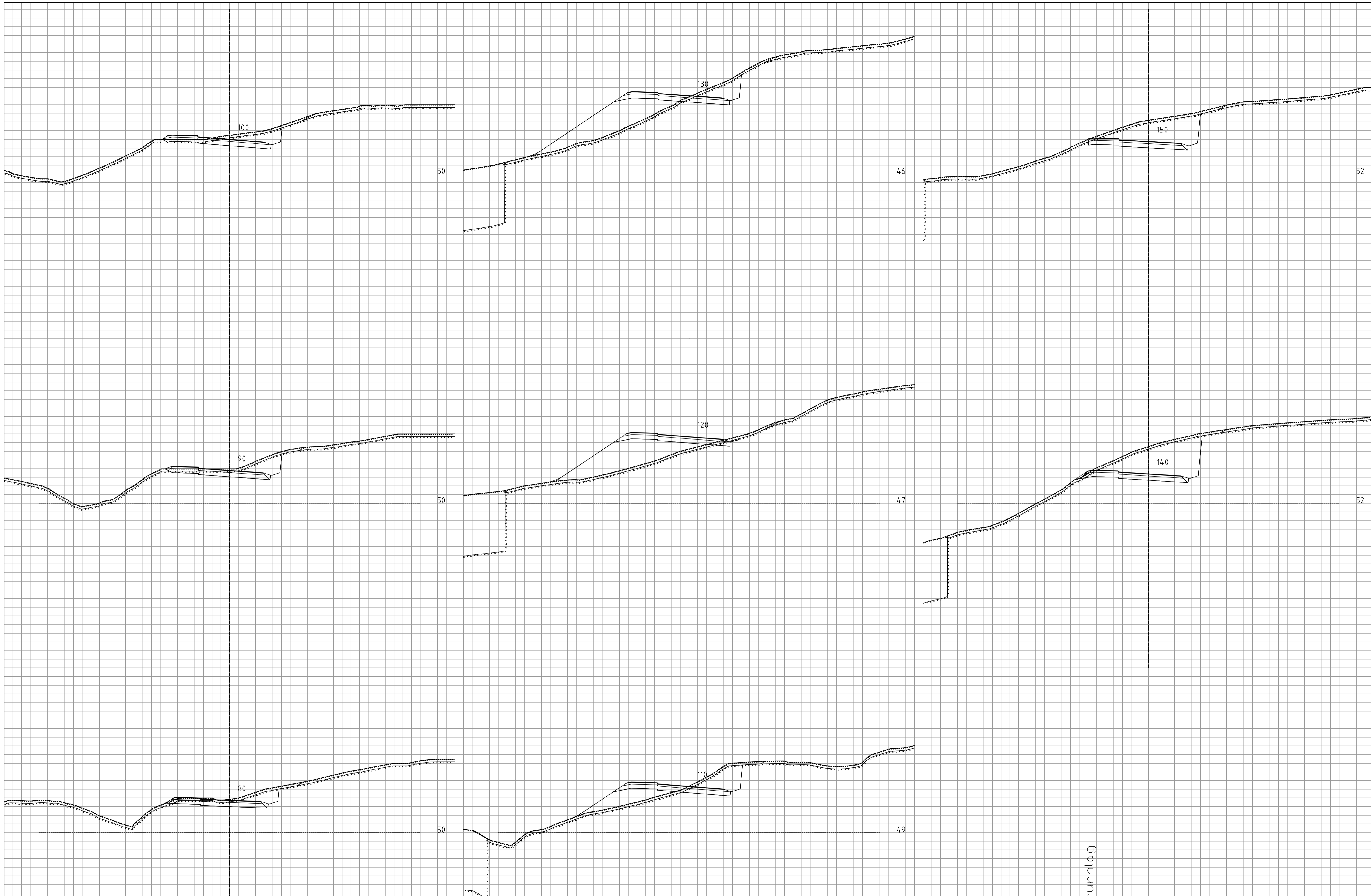

PRODUCED BY AN AUTODESK STUDENT VERSION

PRODUCED BY AN AUTODESK STUDENT VERSION

konkurransegrunnlag

Rev.	Dato	Sign.	Revisjonen gjelder		
Oppdragsgiver			Høgskulen på Vestlandet		
Prosjekt			Tegn.	Kontr.	Godkj.
fv.5161 Åsen-Helleskaret			M.H.□		B.A.N
Tverrprofiler profil 80-150			Dato: 19.05.21		
Tilkomstveg Revsåsen (Veg 20000)			Målestokk:	Format:	
			1:200	A1	
			Prosjekt nr.		
			Tegningsnr.	Rev.	
			U102		

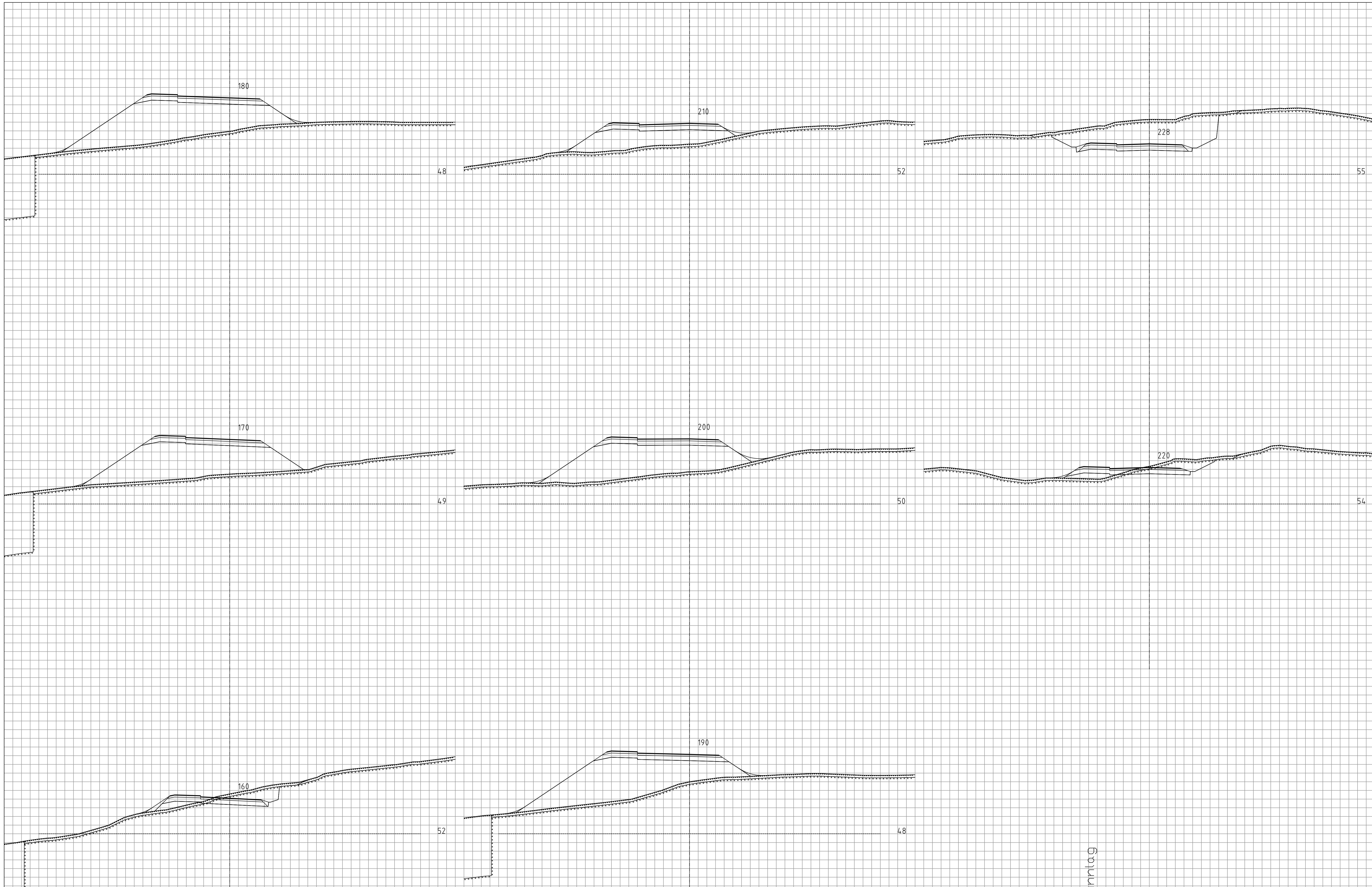

konkurransegrunnlag

Rev.	Dato	Sign.	Revisjonen gjelder		
Oppdragsgiver			Høgskulen på Vestlandet		
Prosjekt			Tegn.	Kontr.	Godkj.
f.v.5161 Åsen-Helleskaret			M.H.□		B.A.N
Tverrprofiler profil 160-228			Dato: 19.05.21		
Tilkomstveg Revsåsen (Veg 20000)			Målestokk:	Format:	
			1:200	A1	
			Prosjektnr.		
			Tegningsnr.	Rev.	
			U103		

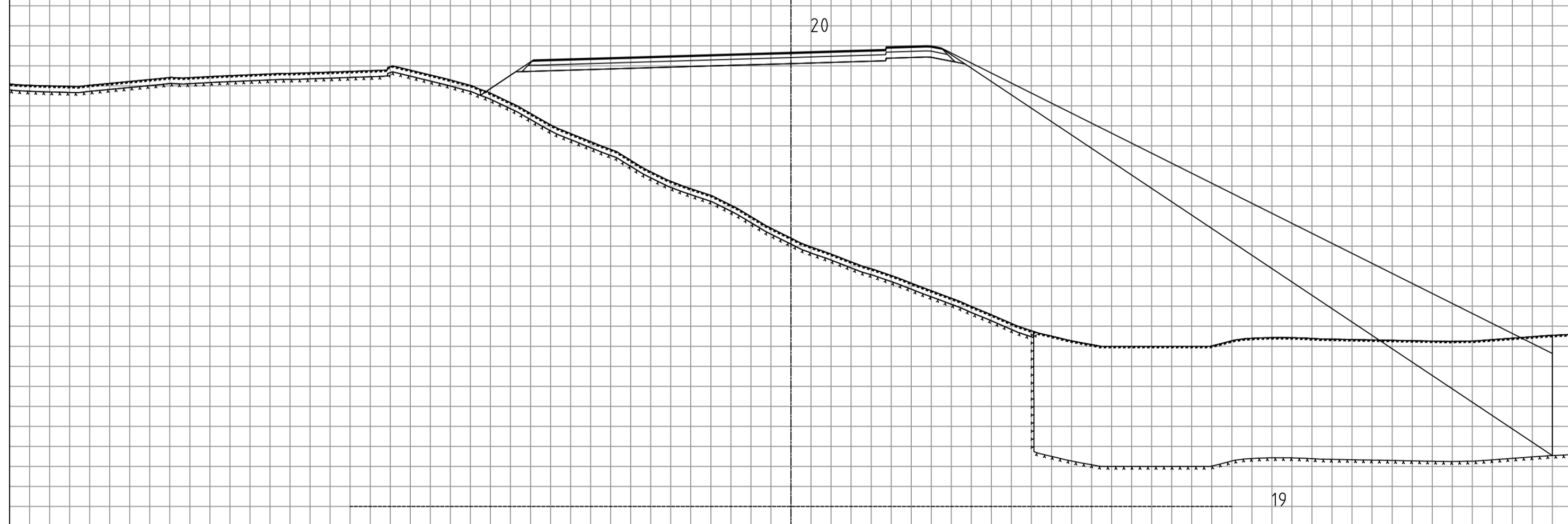
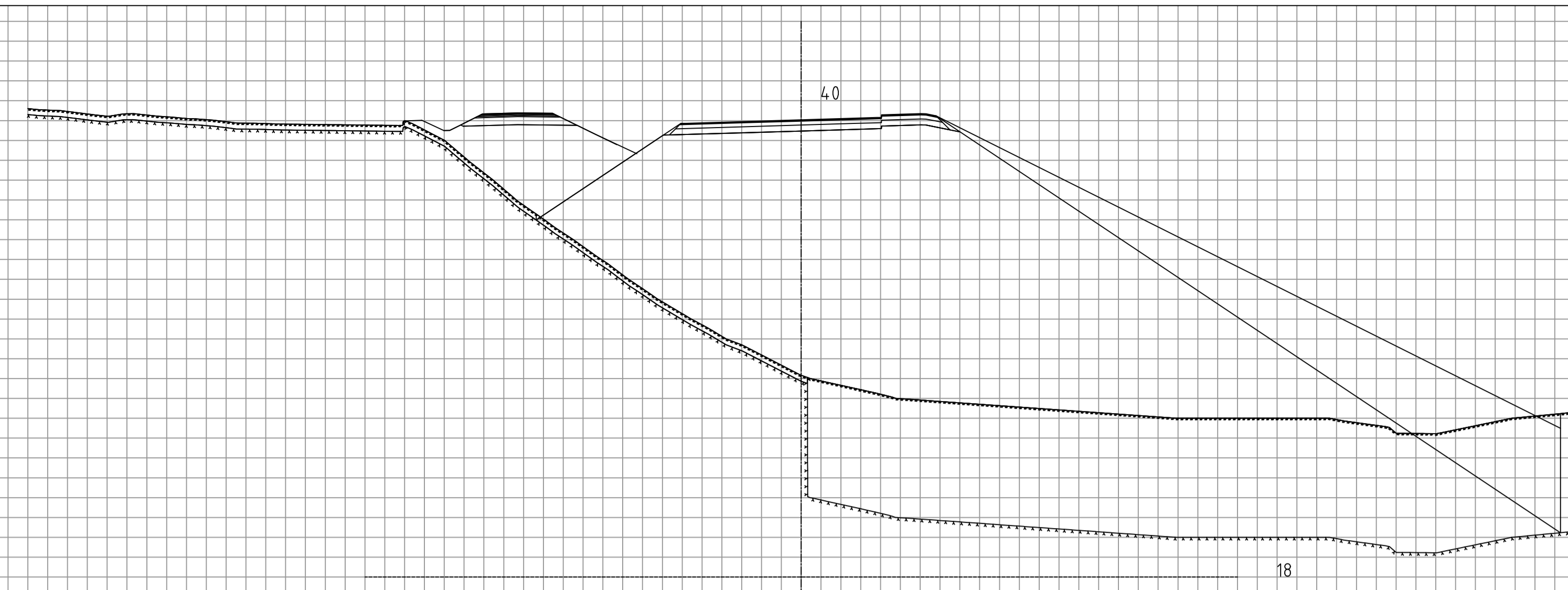
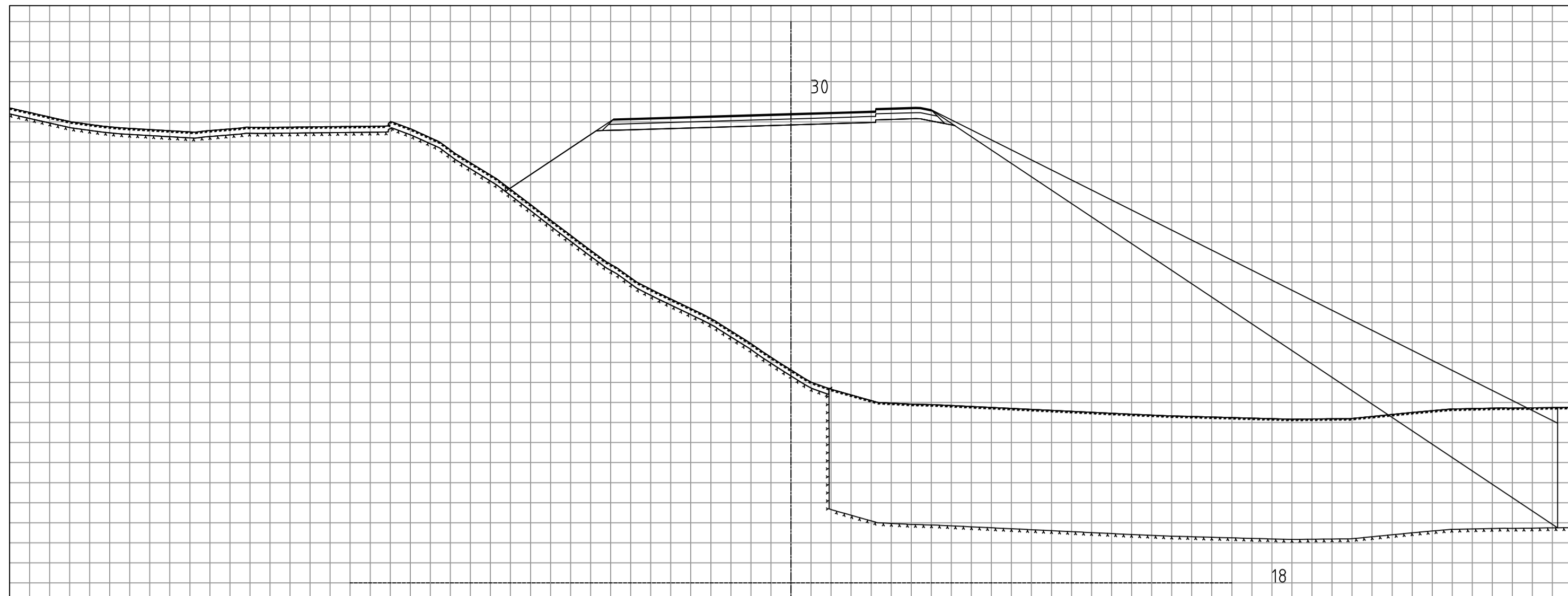

Konkurransegrunnlag

Rev.	Dato	Sign.	Revisjonen gjelder		
Oppdragsgiver			Høgskulen på Vestlandet		
Prosjekt			Tegn.	Kontr.	Godkj.
fv.5161 Åsen-Helleskaret			M.H.□		B.A.N
Tverrprofiler profil 20-40			Dato: 19.05.21		
Søvikvegen (Veg 20200)			Målestokk:	Format:	
			1:200	A1	
			Prosjektnr.		
			Tegningnr.	Rev.	
			U201		

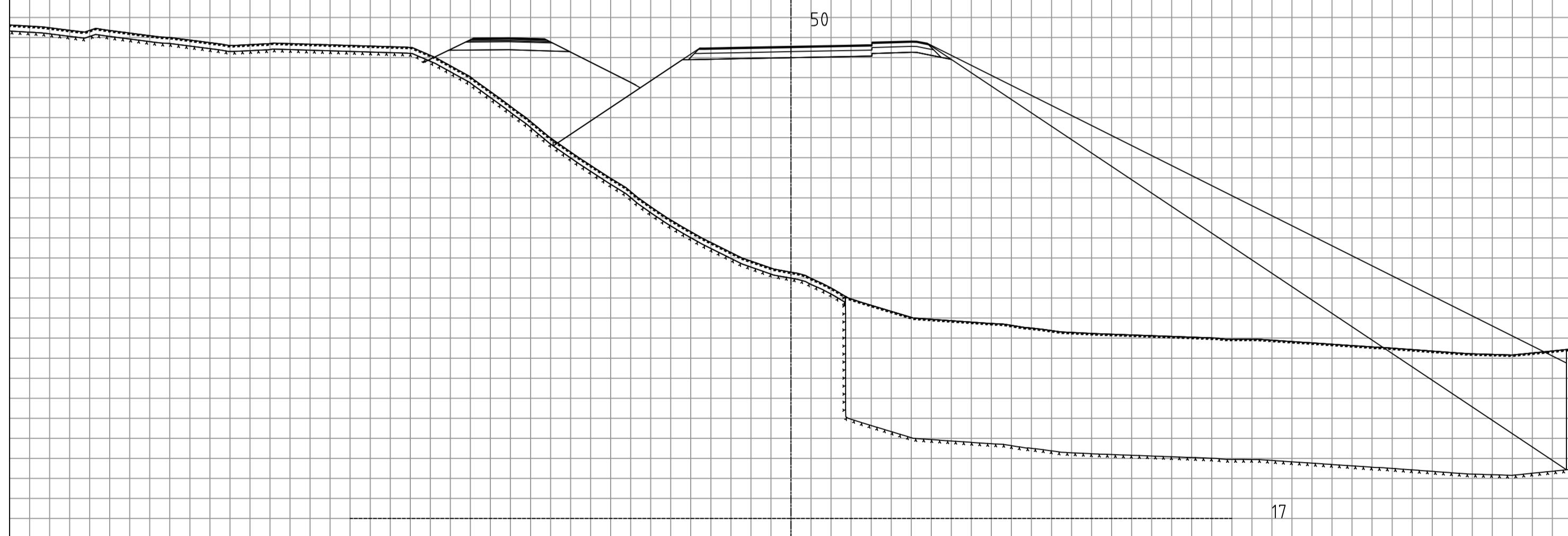
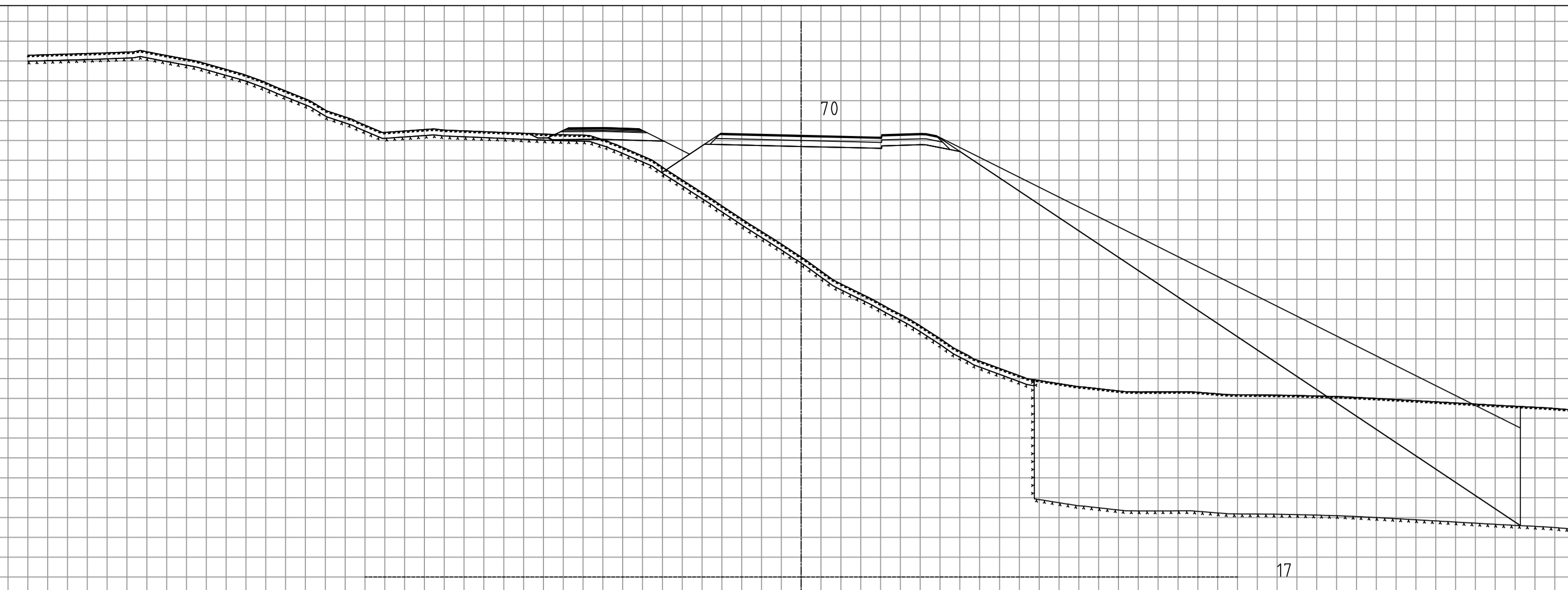
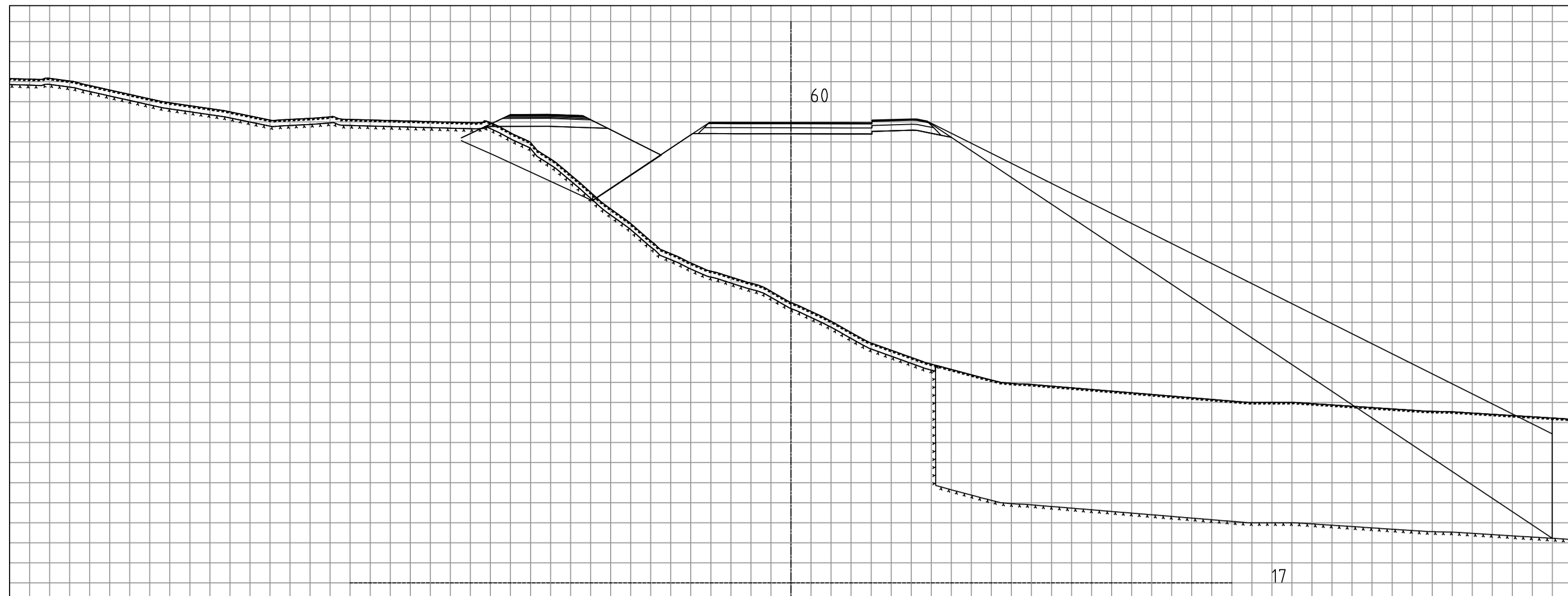

Konkurransegrunnlag

Rev.	Dato	Sign.	Revisjonen gjelder		
Oppdragsgiver			Høgskulen på Vestlandet		
Prosjekt			Tegn.	Kontr.	Godkj.
fv.5161 Åsen-Helleskaret			M.H.Ø		B.A.N
Tverrprofiler profil 50-70			Dato: 19.05.21		
Søvikvegen (Veg 20200)			Målestokk:	Format:	
			1:200	A1	
			Prosjektnr.		
			Tegningnr.	Rev.	
			U202		

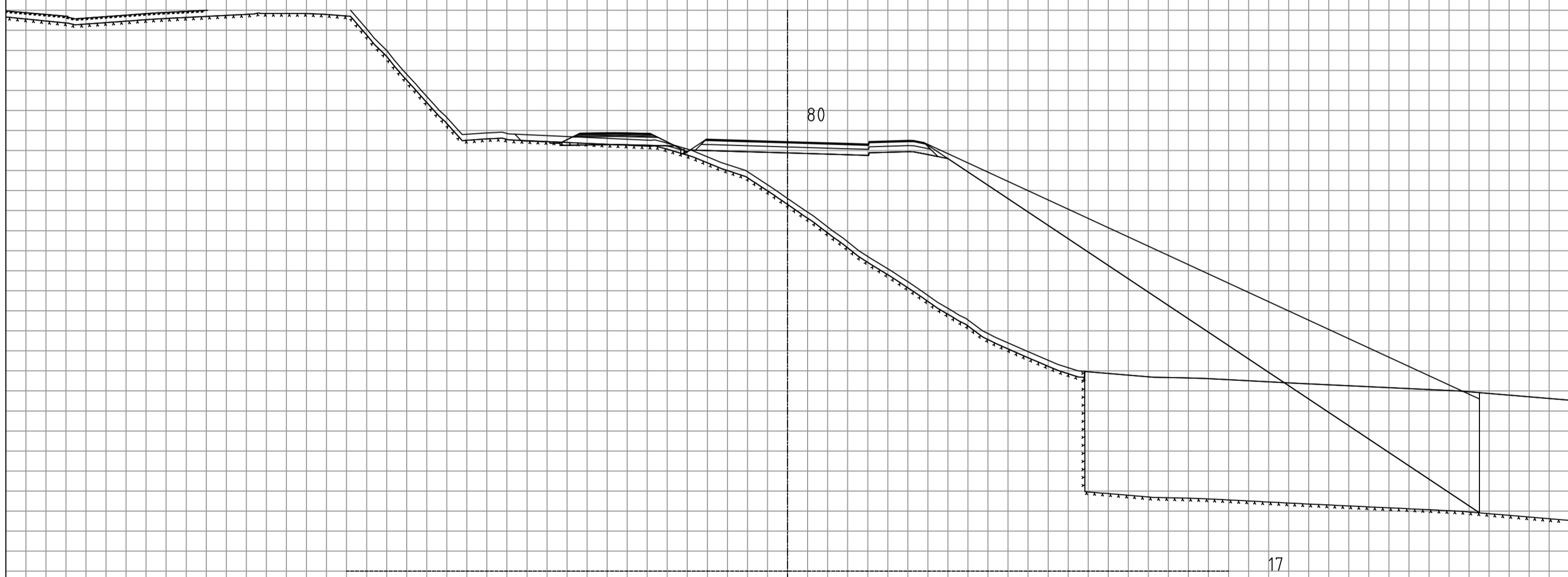
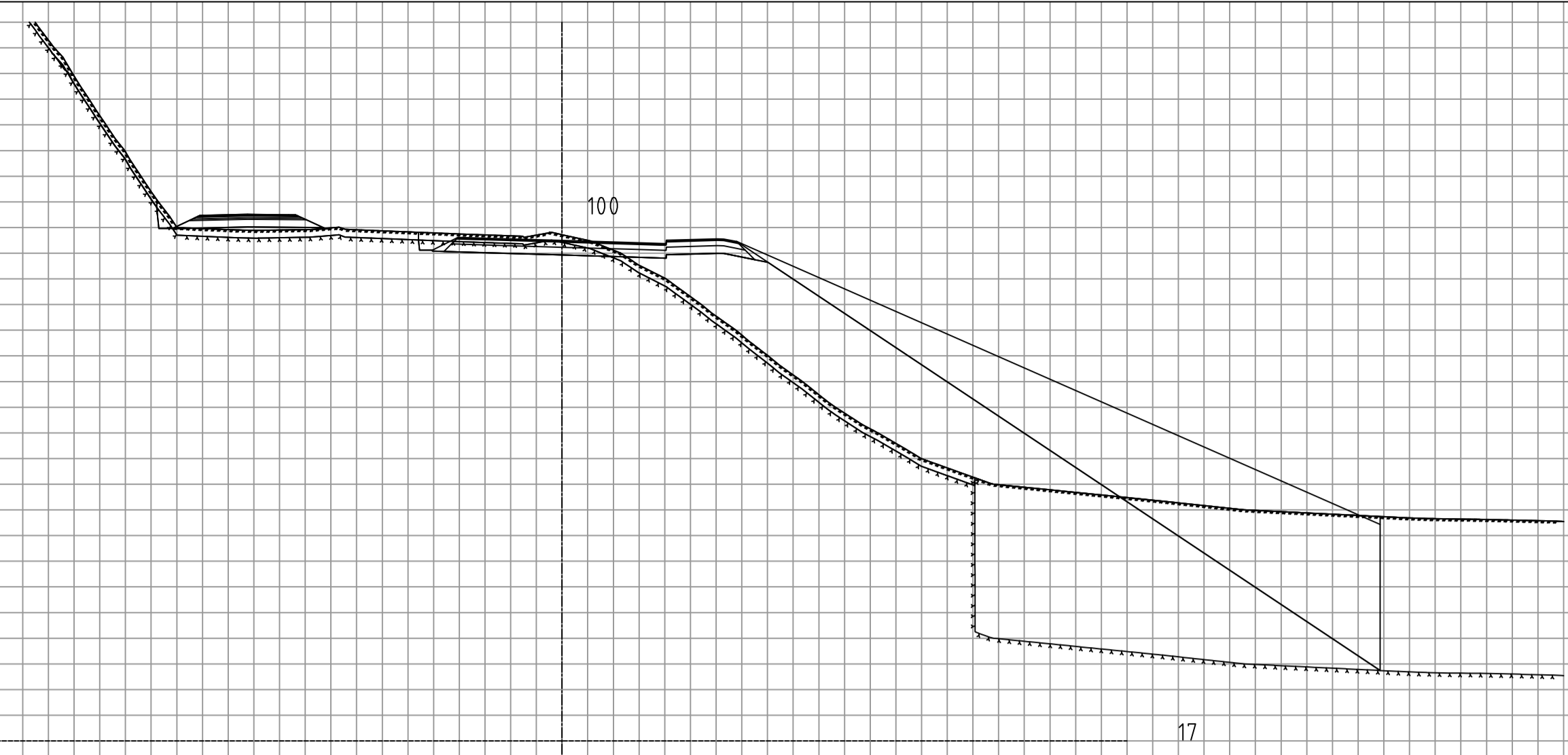
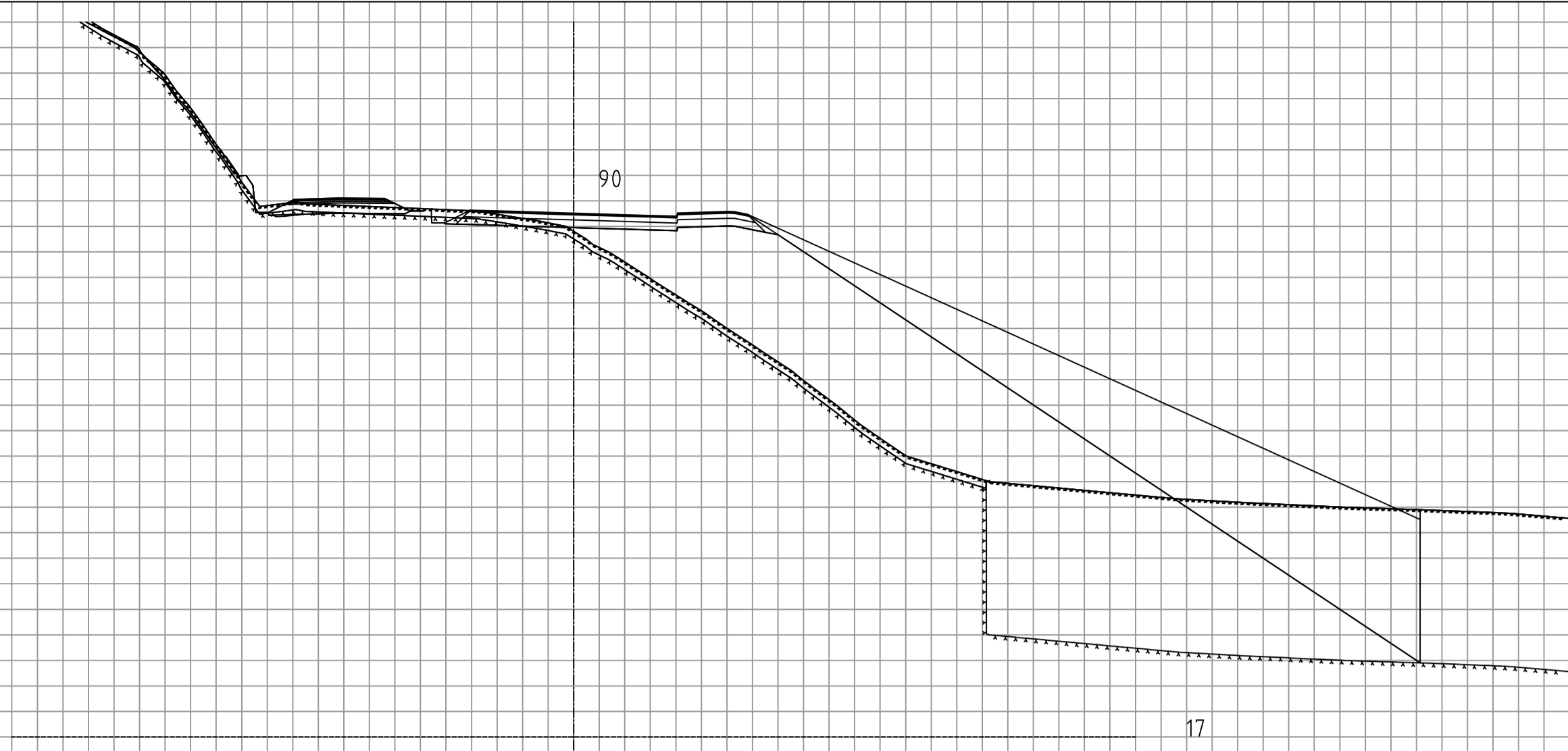

Konkurransegrunnlag

Rev.	Dato	Sign.	Revisjonen gjelder		
Oppdragsgiver			Høgskulen på Vestlandet		
Prosjekt			Tegn.	Kontr.	Godkj.
fv.5161 Åsen-Helleskaret			M.H.Ø		B.A.N
Tverrprofiler profil 80-100			Dato: 19.05.21		
Søvikvegen (Veg 20200)			Målestokk:	Format:	
			1:200	A1	
			Prosjektnr.		
			Tegningsnr.	Rev.	
			U203		



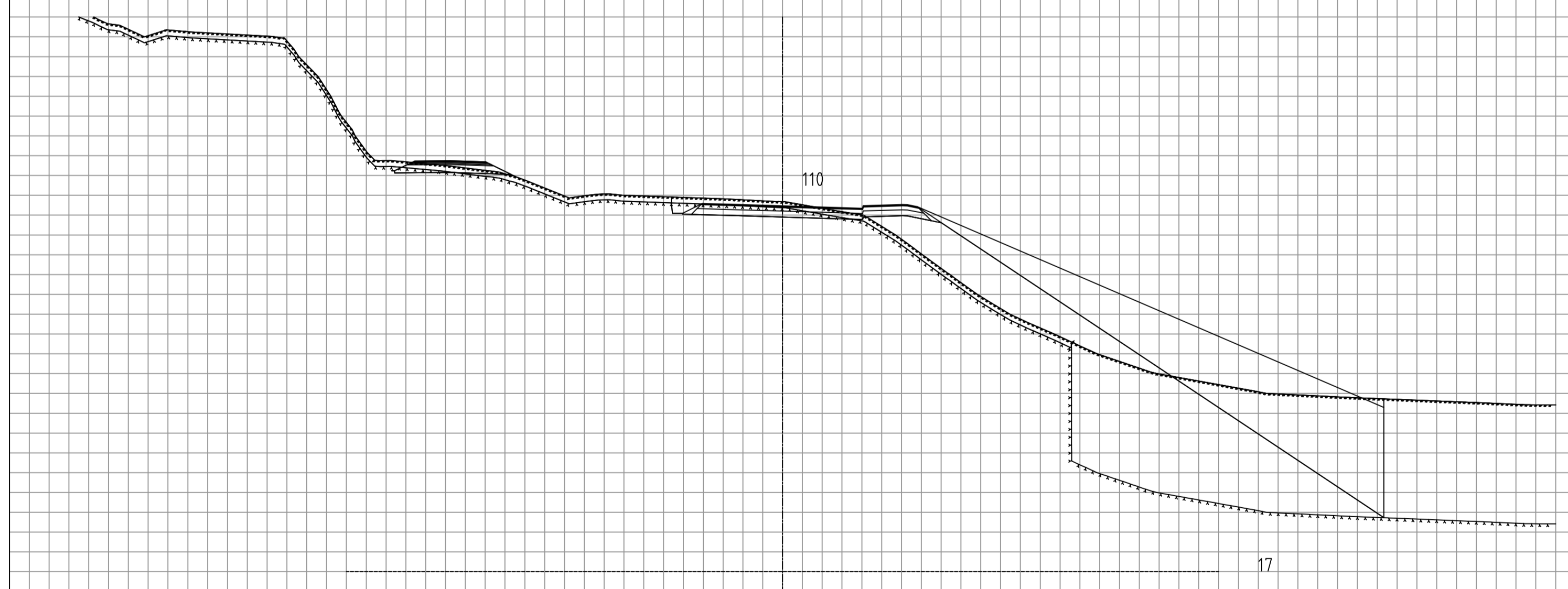
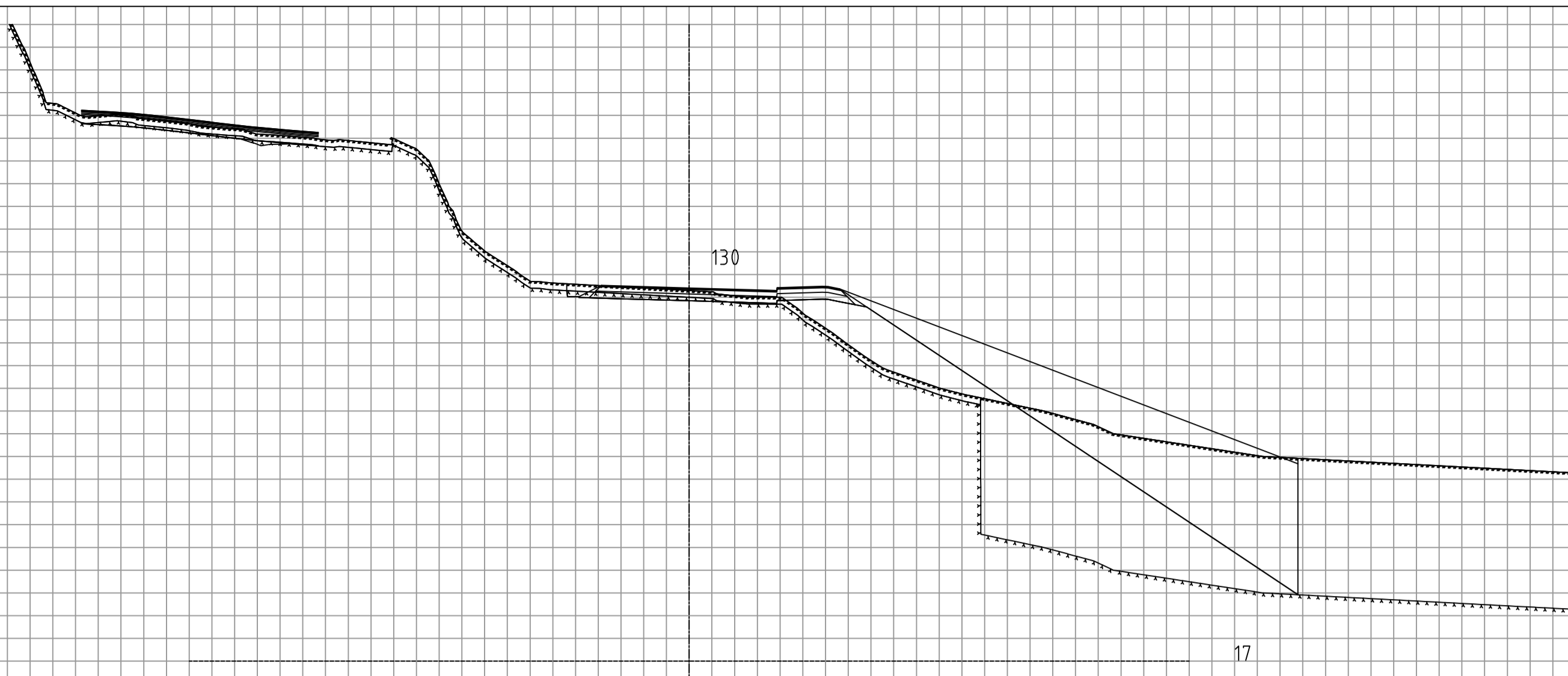
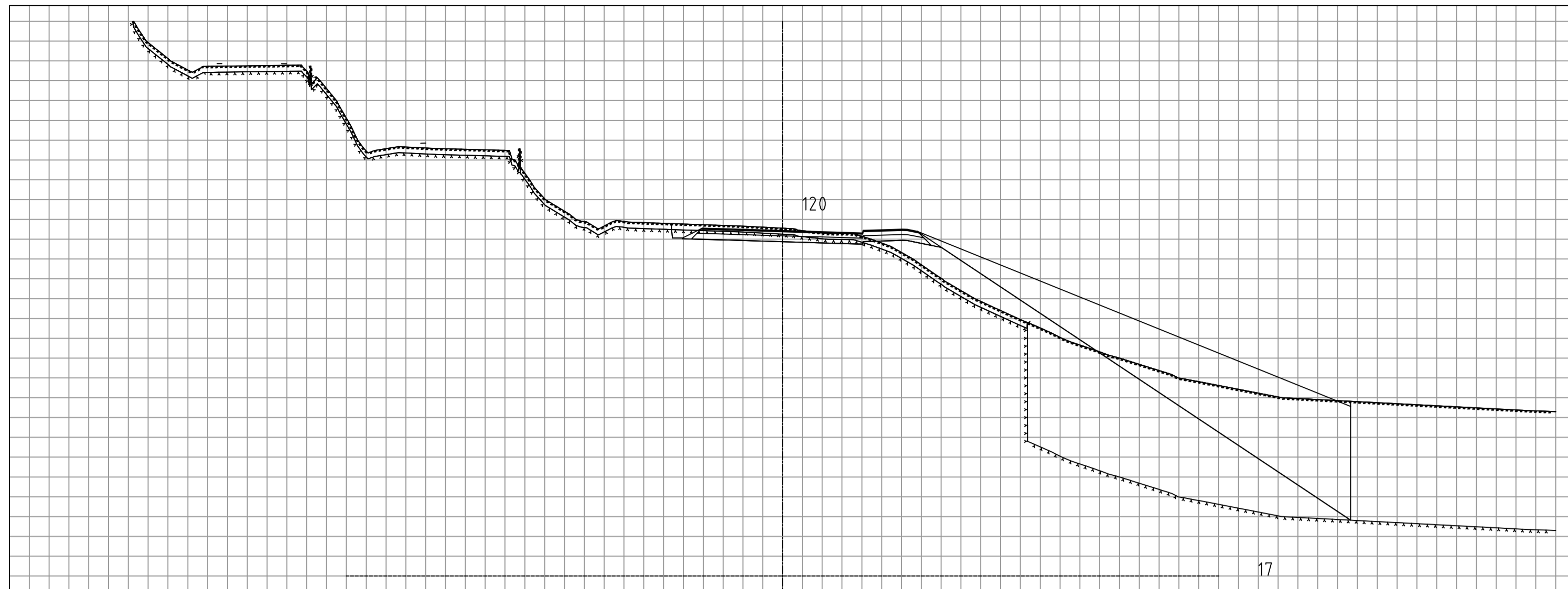

Konkurransegrunntegning

Rev.	Dato	Sign.	Revisjonen gjelder		
Oppdragsgiver			Høgskulen på Vestlandet		
Prosjekt			Tegn.	Kontr.	Godkj.
fv.5161 Åsen-Helleskaret			M.H.D		B.A.N
Tverrprofiler profil 110-130			Dato: 19.05.21		
Søvikvegen (Veg 20200)			Målestokk:	Format:	
			1:200	A1	
			Prosjektnr.		
			Tegningnr.	Rev.	
			U204		